



CERTIFICATE OF APPROPRIATENESS PLACARD

for Raleigh Historic Resources

115 W MORGAN STREET

Address

CAPITOL SQUARE

Historic District

RALEIGH WATER TOWER

Historic Property

155-17-MW

Certificate Number

09-25-2017

Date of Issue

03-25-2018

Expiration Date

Project Description:

- Refurbishing windows; installation of new storm windows

This card must be kept pasted in a location within public view until all phases of the described project are complete. The work must conform with the code of the City of Raleigh and laws of the state of North Carolina. When your project is complete, you are required to ask for a final zoning inspection in a historic district area. Telephone the RHDC office at 832-7238 and commission staff will coordinate the inspection with the Inspections Department. If you do not call for this final inspection, your Certificate of Appropriateness is null and void.

Signature, _____

Raleigh Historic Development Commission

Pending the resolution of appeals, commencement of work is at your own risk.

Raleigh Historic Development Commission – Certificate of Appropriateness (COA) Application



**DEVELOPMENT
SERVICES
DEPARTMENT**

Development Services
Customer Service Center
One Exchange Plaza
1 Exchange Plaza, Suite 400
Raleigh, North Carolina 27601
Phone 919-996-2495
eFax 919-996-1831



<input checked="" type="checkbox"/> Minor Work (staff review) – 1 copy <input type="checkbox"/> Major Work (COA Committee review) – 10 copies <input type="checkbox"/> Additions Greater than 25% of Building Square Footage <input type="checkbox"/> New Buildings <input type="checkbox"/> Demo of Contributing Historic Resource <input type="checkbox"/> All Other <input type="checkbox"/> Post Approval Re-review of Conditions of Approval	<p style="text-align: center;">For Office Use Only</p> Transaction # <u>527231</u> File # <u>155-17-MW</u> Fee <u>29</u> Amount Paid <u>29</u> Received Date <u>8/25/17</u> Received By <u>(Signature)</u>
--	--

Property Street Address **115 W. Morgan Street**

Historic District **Capitol Square**

Historic Property/Landmark name (if applicable) **Raleigh Water Tower**

Owner's Name **S&A Real Estate, LLC**

Lot size **0.09 acres** (width in feet) **35** (depth in feet) **110**

For applications that require review by the COA Committee (Major Work), provide addressed, stamped envelopes to owners of all properties within 100 feet (i.e. both sides, in front (across the street), and behind the property) not including the width of public streets or alleys (Label Creator).

Property Address	Property Address

I understand that all applications that require review by the commission's Certificate of Appropriateness Committee must be submitted by 4:00 p.m. on the application deadline; otherwise, consideration will be delayed until the following committee meeting. An incomplete application will not be accepted.

Type or print the following:

Applicant S&A Real Estate, LLC

Mailing Address 2401 Dix Street

City Raleigh

State NC

Zip Code 27609

Date 08/25/2017

Daytime Phone 919-559-2575

Email Address ryan@adamshowell.com

Applicant Signature 

Office Use Only

Will you be applying for rehabilitation tax credits for this project? Yes No

Type of Work _____

84, 85

Did you consult with staff prior to filing the application? Yes No

Design Guidelines - Please cite the applicable sections of the design guidelines (www.rhdc.org).

Section/Page	Topic	Brief Description of Work (attach additional sheets as needed)
84/15	Alteration/Removal of existing windows, sash, opening or trim	<p data-bbox="722 1182 1471 1423">Double Hung Windows is refurbishing the windows in the water tower. After they repair and repaint the windows, they are going back with a protective window over the original windows like what First Presbyterian has on their windows so we do not have to worry about continued painting and maintenance which requires a crane to accomplish.</p> <p data-bbox="722 1465 1481 1535">A copy of the proposal from Double Hung Windows with the scope of work is attached.</p>

Minor Work Approval (office use only)

Upon being signed and dated below by the Planning Director or designee, this application becomes the Minor Work Certificate of Appropriateness. It is valid until 3/25/18. Please post the enclosed placard form of the certificate as indicated at the bottom of the card. Issuance of a Minor Work Certificate shall not relieve the applicant, contractor, tenant, or property owner from obtaining any other permit required by City Code or any law. Minor Works are subject to an appeals period of 30 days from the date of approval.

Signature (City of Raleigh) Melissa Robb Date 9/25/17

	TO BE COMPLETED BY APPLICANT		TO BE COMPLETED BY CITY STAFF		
	YES	N/A	YES	NO	N/A
Attach 8-1/2" x 11" or 11" x 17" sheets with written descriptions and drawings, photographs, and other graphic information necessary to completely describe the project. Use the checklist below to be sure your application is complete. <u>Minor Work (staff review) – 1 copy</u> <u>Major Work (COA Committee review) – 10 copies</u>					
1. Written description. Describe clearly and in detail the nature of your project. Include exact dimensions for materials to be used (e.g. width of siding, window trim, etc.)	<input type="checkbox"/>				
2. Description of materials (Provide samples, if appropriate)	<input type="checkbox"/>				
3. Photographs of existing conditions are required. Minimum image size 4" x 6" as printed. Maximum 2 images per page.	<input type="checkbox"/>				
4. Paint Schedule (if applicable)	<input type="checkbox"/>	<input type="checkbox"/>			
5. Plot plan (if applicable). A plot plan showing relationship of buildings, additions, sidewalks, drives, trees, property lines, etc., must be provided if your project includes any addition, demolition, fences/walls, or other landscape work. Show accurate measurements. You may also use a copy of the survey you received when you bought your property. Revise the copy as needed to show existing conditions and your proposed work.	<input type="checkbox"/>	<input type="checkbox"/>			
6. Drawings showing existing and proposed work <input type="checkbox"/> Plan drawings <input type="checkbox"/> Elevation drawings showing the façade(s) <input type="checkbox"/> Dimensions shown on drawings and/or graphic scale (required) <input type="checkbox"/> 11" x 17" or 8-1/2" x 11" reductions of full-size drawings. If reduced size is so small as to be illegible, make 11" x 17" or 8-1/2" x 11" snap shots of individual drawings from the big sheet.	<input type="checkbox"/>	<input type="checkbox"/>			
7. Stamped envelopes addressed to all property owners within 100 feet of property not counting the width of public streets and alleys (required for Major Work). Use the <u>Label Creator</u> to determine the addresses.	<input type="checkbox"/>	<input type="checkbox"/>			
8. Fee (<u>See Development Fee Schedule</u>)	<input type="checkbox"/>				

Robb, Melissa

From: Ryan Adams <ryan@adamshowell.com>
Sent: Monday, September 25, 2017 6:58 AM
To: Robb, Melissa
Cc: Tully, Tania; 'agshirley85@gmail.com'
Subject: RE: Minor work COA application - Raleigh Water Tower

Melissa,
The windows will be painted back white, which is the same color they are now. The finish color on the storm windows will also be white.

Let me know if you need anything else.

Thanks,

Ryan J. Adams

Adams, Howell, Sizemore & Lenfestey, P.A.
1600 Glenwood Ave. Suite 101, Raleigh, NC 27608
Phone: 919.900.4700
Direct: 919.899.6278
Facsimile: 919.839.2230
ryan@adamshowell.com
Offices in: Raleigh | Charlotte | Indianapolis | Cary | Angier
www.adamshowell.com

From: Robb, Melissa [<mailto:Melissa.Robb@raleighnc.gov>]
Sent: Friday, September 22, 2017 4:09 PM
To: Ryan Adams <ryan@adamshowell.com>
Cc: Tully, Tania <Tania.Tully@raleighnc.gov>
Subject: Minor work COA application - Raleigh Water Tower

Ryan,

In reviewing your Certificate of Appropriateness (COA) application for the window restoration work at 115 W Morgan St, staff has a few questions:

- What will the final finish be on the windows? Will it be paint or stain? What color? Is it different from what is there now?
- What will the final finish be on the exterior storm windows?

If the finish color is different from what is currently on the windows, we will need to have you supply a color swatch from the manufacturer. Once we receive this information we will be able to complete processing your application.

Best,
Melissa

Melissa Robb, Planner II
Raleigh Historic Development Commission



Double Hung, LLC

Historic Window Restoration

2801 Patterson Ave

Greensboro, NC 27407

Phone: 888.235.8956

Fax: 866.681.1080

January 12, 2017

Raleigh Water Tower

Full Restoration - Wood Window Quote and Scope of Work

Exterior Aluminum Storm Windows

7 Each DH Gothic Top Windows

Phasing: All work to completed in one phase

Wood Window Restoration and Replication Scope

Sash (Stile, rail, muntin, hardware, and glazing)

- Remove sash as needed(wood windows), install temporary protection, catalogue components, transport to shop, completely remove paint/putty, restore utilizing "Dutchman" and consolidation techniques, repair deteriorated sash members, re-glaze, prime coat, and reinstall sash.
- Tyvek and OSB will be used as temporary protection. Customer is responsible for maintaining temporary protection while sash are out.
- Sash – paint removal to sound substrate. Insure proper moisture content before proceeding with restoration work. Sand to prime surface.
- Historic Glazing - Retain and reinstall original glass if undamaged. Replace all broken, cracked, scratched, split or missing original glass with clear 1/8" annealed flat glass.
- Shop clean glass to remove glazing residue. Final glass is included.
- Apply boiled linseed oil to glazing rebate prior to glaze putty installation or prime coat glazing rebate with Ben Moore Freshstart or approved equal.
- Install new, linseed oil-based glaze putty. Knife to smooth, seamless finish. Allow minimum of 7 days "dry time" prior to delivery. Sarco glaze putty does not require a prime coat.
- Apply 2 coats of finish paint to exterior.
- Reinstall top and bottom double hung sash fixed.

Frames (Jambs, header, wood sills, interior stop and blind stop)

- Repair scheduled wood window frames in place.
- Interior Stop Molding - Remove, catalogue, retain, and reinstall existing. If any member is deemed unserviceable, replicate, prime and install new stop as needed.
- Parting Stop – Remove, and evaluated for re-use. Mill prime and install new parting stop as needed.
- Jamb, sill, header & blind stop – minimal paint preparation work scheduled, remove paint to sound substrate.
- Replicate and install missing or heavily deteriorated material.
- Consolidate deteriorated elements as needed including sills. Replace elements if over 30% deteriorated.
- Sand/fill repairs to blend with original.
- Prime coat frame, interior stop, parting bead and sill and trim (Ben Moore Fresh Start or approved equal).
- Apply 2 finish coats to same members.

"Don't replace... repair"

estimating@double-hung.com

Allied AOL Series 1 Lite Gothic Top Storm Windows. (7 Each)

- Standard mfg. Colors.
- Clear annealed glass.
- Installed (exterior mount).
- Final glass cleaning is included.

Scope of Work Inclusions

1. Scope of Work above.
2. Coordination of schedule with owner/owner's representative.
3. One Year Warranty on materials and workmanship.

Scope of Work Exclusions

1. Other processes not included in Scope.

Total Materials and Labor.....\$32,010.00

Terms:

- 30% due on order to proceed.
- Balance due on completion.

Reckhow, Hannah

From: Ryan Adams <ryan@adamshowell.com>
Sent: Tuesday, August 29, 2017 7:13 AM
To: Reckhow, Hannah
Subject: RE: Raleigh Water Tower COA - additonal details
Attachments: H-2 HOL A.PDF; HOL-Specs.doc

Hannah,
David Hoggard from Double Hung provided the following:
They are the Allied Windows's HOL (Historic One Light). Here is the [webpage](#).

The cut sheet for the specifications and drawing are attached.

Hope this helps.

You might tell them that we also recently installed these – to the interior – on the the Old State Capital building.

Let me know if you need anything else.

Thanks,

Ryan J. Adams

Adams, Howell, Sizemore & Lenfestey, P.A.
1600 Glenwood Ave. Suite 101, Raleigh, NC 27608
Phone: 919.900.4700
Direct: 919.899.6278
Facsimile: 919.839.2230
ryan@adamshowell.com
Offices in: Raleigh | Charlotte | Indianapolis | Cary | Angier
www.adamshowell.com

From: Reckhow, Hannah [<mailto:Hannah.Reckhow@raleighnc.gov>]
Sent: Monday, August 28, 2017 1:17 PM
To: Ryan Adams <ryan@adamshowell.com>
Subject: Raleigh Water Tower COA - additonal details

Ryan,

I am writing with a follow up question regarding your COA Minor Work application for the Raleigh Water Tower. Would you be able to provide more detail about the appearance and mounting of the external storm windows to be installed?

Best regards,

Hannah Reckhow

Planner I
Raleigh Department of City Planning
One Exchange Plaza, Suite 300 (27601)

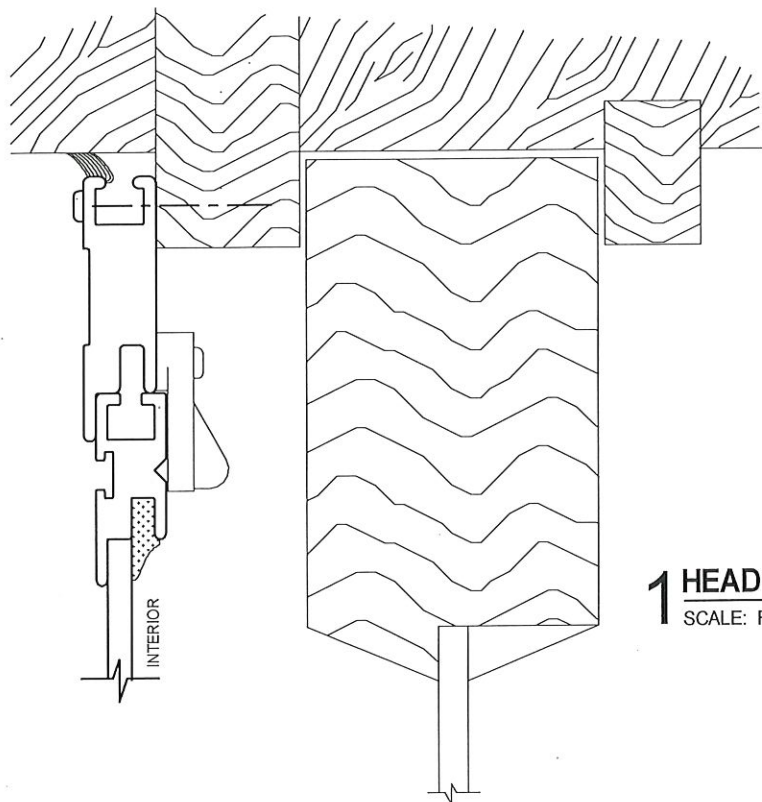

1 HEAD DETAIL
SCALE: FULL

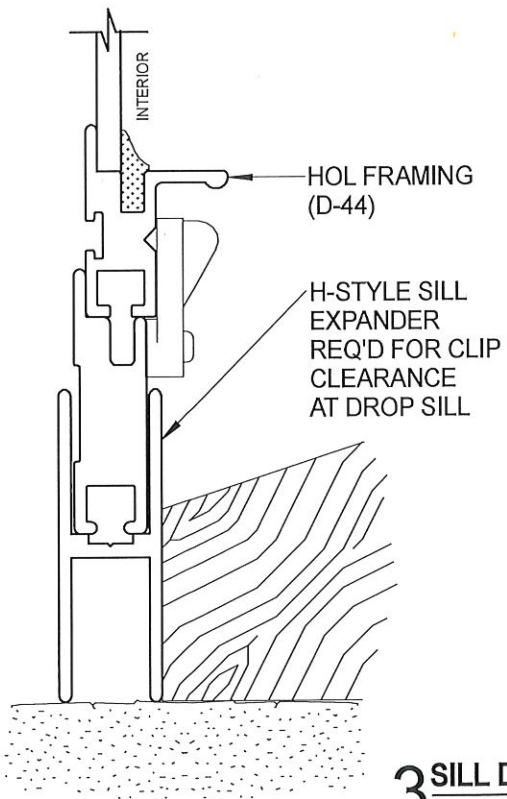
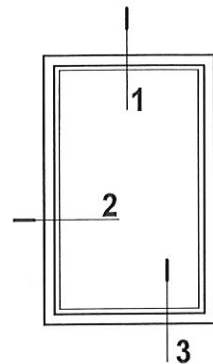

3 SILL DETAIL
SCALE: FULL

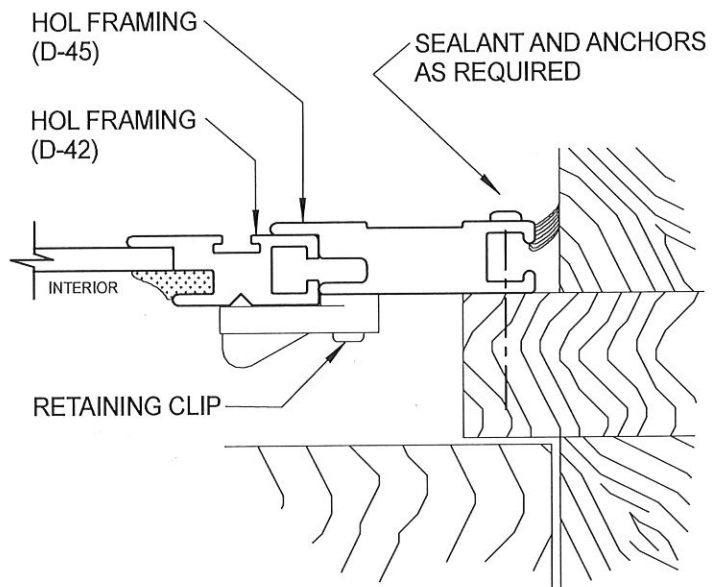

2a JAMB DETAIL
SCALE: FULL

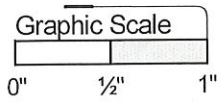

NOTE: INTERCHANGEABLE SCREEN AVAILABLE

PRODUCT
HISTORIC ONE LITE • HOL-A
SINGLE REMOVABLE PANEL

DWG. NO.
H-2

 **Allied Window**
Performance Panels®

11111 CANAL ROAD • CINCINNATI, OH 45241 • PH: 800-445-5411, 513-559-1212 • FAX: 513-559-1883 • www.alliedwindow.com • info@alliedwindow.com

SPECIFICATIONS “HOL” HISTORIC ONE LITE

APPLICATION: EXTERIOR INSTALLATION: INSERTS REMOVE DIRECTLY TO INTERIOR

PART 1 – GENERAL

1.1 SCOPE. All aluminum windows of the types and sizes shown in the plans and/or as called for in this specification shall be furnished with all necessary hardware, fasteners and miscellaneous equipment as herein specified and shall be manufactured by Allied Window, Inc. Quality standards shall be as described within these specifications.

PART 2 – MATERIALS

2.1 ALLOYS. Aluminum shall be of commercial quality and of proper alloy for window construction free from defects impairing strength and durability. All straight extruded sections shall be of 6063-T5 alloy and temper and shall have a minimum ultimate tensile strength of 22,000 P.S.I. and a yield of 16,000 P.S.I.

2.2 WINDOW MEMBERS. Master frame members shall be of extruded aluminum with a 3/8" x 1 3/8" dimension. All extrusions shall be of sufficient strength to perform as designed. Window members shall have a nominal wall thickness of not less than .062". All corner keys shall be of extruded aluminum.

2.3 FASTENERS. All screws and other miscellaneous fastening devices incorporated shall be zinc plated, cadmium plated or other non-corrosive metals compatible with aluminum.

2.4 HARDWARE. All insert clips shall be nylon, or zinc die cast.

PART 3 – CONSTRUCTION

3.1 ASSEMBLY. All windows shall be assembled in a secure and workmanlike manner. The master frame and insert frame(s) shall be of mitered head and sill. Frame rails and stiles shall be neatly joined together using extruded aluminum corner keys staked in place.

3.2 SILL EXPANDER. Sill expander shall be of "H" type with minimum wall thickness of .062" and .125" web thickness, and modified to permit weepage.

3.3 INSERTS. Insert(s) shall be freely removable and equipped with a full bottom rail lift handle. Insert(s) held in place by cam action clips.

3.4 HARDWARE. Latching clips shall have cam action and provide positive seal between master frame and insert(s). NO hardware shall be visible on exterior of units.

Close Window

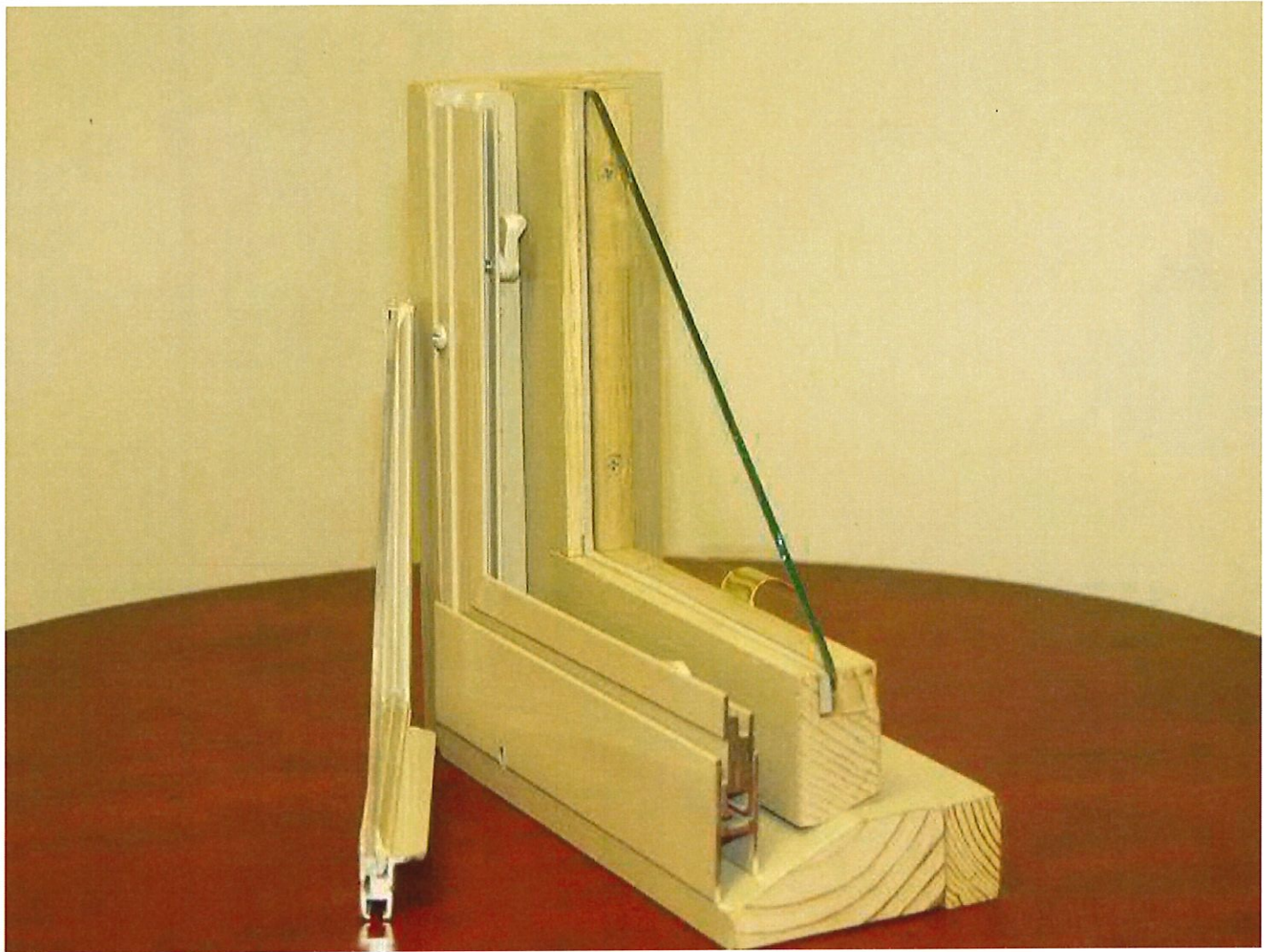

Close Window

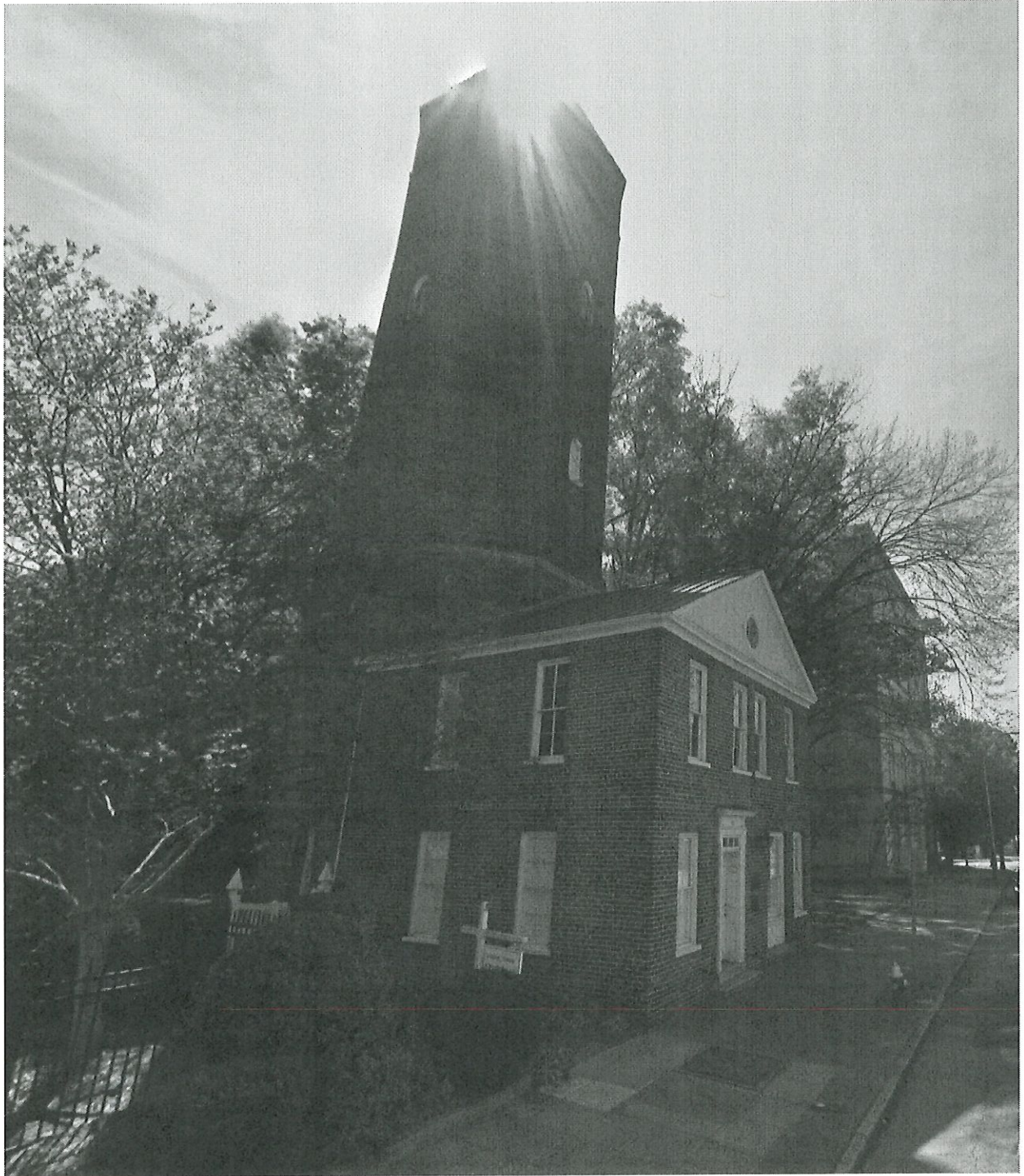



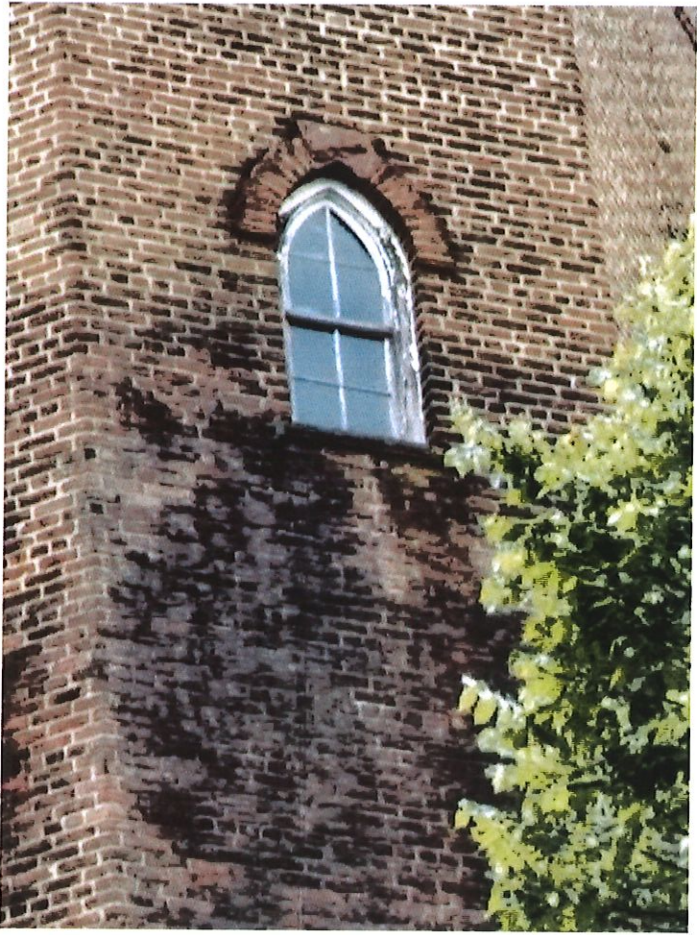

[Add a comment](#)

