



# CERTIFICATE OF APPROPRIATENESS PLACARD

for Raleigh Historic Resources

218 N EAST STREET

Address

OAKWOOD

Historic District

HECK-POOL HOUSE

Historic Property

161-16-MW

Certificate Number

09-23-2016

Date of Issue

03-23-2017

Expiration Date

### Project Description:

- Repair and replace gutters;
- replace carriage house roof;
- install new gravel;
- install brick wall;
- install brick steps, landing and patio,
- remove damaged tree;
- plant new tree;
- relocate trees

*This card must be kept pasted in a location within public view until all phases of the described project are complete. The work must conform with the code of the City of Raleigh and laws of the state of North Carolina. When your project is complete, you are required to ask for a final zoning inspection in a historic district area. Telephone the RHDC office at 832-7238 and commission staff will coordinate the inspection with the Inspections Department. If you do not call for this final inspection, your Certificate of Appropriateness is null and void.*

Signature,   
Raleigh Historic Development Commission

*Pending the resolution of appeals, commencement of work is at your own risk.*



# Planning & Development

Development Services  
 Customer Service Center  
 One Exchange Plaza  
 1 Exchange Plaza, Suite 400  
 Raleigh, North Carolina 27601  
 Phone 919-996-2495  
 eFax 919-996-1831

## Raleigh Historic Development Commission – Certificate of Appropriateness (COA) Application



- Minor Work (staff review) – 1 copy
- Major Work (COA Committee review) – 13 copies
  - Most Major Work Applications
  - Additions Greater than 25% of Building Square Footage
  - New Buildings
  - Demo of Contributing Historic Resource
- Post Approval Re-review of Conditions of Approval

**For Office Use Only**

Transaction # 464506

File # 161-16-MW

Fee \$ 29.00

Amt Paid \$ 29.00

Check # 1671

Rec'd Date 3/7/16

Rec'd By [Signature]

App Complete 3/19/16

• If completing by hand, please use **BLACK INK**. Do not use blue, red, any other color, or pencil as these do not photocopy. Amended too  
Complete 9/20/16 TGT

Property Street Address **218 N. East Street Raleigh, NC 27601**

Historic District **Oakwood**

Historic Property/Landmark name (if applicable) **Heck-Pool House**

Owner's Name **Randall C. and Heather Lee Scott**

Lot size **0.80 acres** (width in feet) **107.78'** (depth in feet) **323.06'**

For applications that require review by the COA Committee (Major Work), provide addressed, stamped envelopes to owners of all properties within 100 feet (i.e. both sides, in front (across the street), and behind the property) not including the width of public streets or alleys:

Property Address	Property Address
220, 219, 221, 223 & 217 N. East St.	
512, 514, 516 & 518 E. Lane St.	
227, 225, 222 & 221 Elm St.	
503, 511, 503 E. Jones St.	

I understand that all applications that require review by the commission's Certificate of Appropriateness Committee must be submitted by 4:00 p.m. on the application deadline; otherwise, consideration will be delayed until the following committee meeting. An incomplete application will not be accepted.

Type or print the following:

Applicant **Randall & Heather Scott**

Mailing Address **218 N. East Street**

City **Raleigh** State **NC** Zip Code **27601**

Date \_\_\_\_\_ Daytime Phone **919-219-1044**

Email Address **hrose100@yahoo.com**

Signature of Applicant *Randall C. Scott* *Heather Scott*

**Minor Work Approval (office use only)**

Upon being signed and dated below by the Planning Director or designee, this application becomes the Minor Work Certificate of Appropriateness. It is valid until 3/23/17. Please post the enclosed placard form of the certificate as indicated at the bottom of the card. Issuance of a Minor Work Certificate shall not relieve the applicant, contractor, tenant, or property owner from obtaining any other permit required by City Code or any law. Minor work projects not approved by staff will be forwarded to the Certificate of Appropriateness Committee for review at the next scheduled meeting.

Signature *Randall C. Scott* Date 9/23/17

*as Amended*

**Project Categories (check all that apply):**

Exterior Alteration

Addition

New Construction

Demolition

**Will you be applying for state or federal rehabilitation tax credits for this project?**

Yes

No

**(Office Use Only)**

Type of Work \_\_\_\_\_

\_\_\_\_\_

\_\_\_\_\_

\_\_\_\_\_

*Work amended per 8/19/16 email.*

**Design Guidelines** Please cite the applicable sections of the design guidelines ([www.rhdc.org](http://www.rhdc.org)).

Section/Page	Topic	Brief Description of Work
3.5.8 & 9	Gutters	Repair and Replace Existing Gutters
2.6.6	Garages	<del>Add Garage Door to existing carport</del>
2.6.2	Accessory Structures	Replace Carriage House Roof and <del>2 entry doors</del>
2.5.5	Driveways & Parking	Install new decorative gravel upper drive & parking pad
2.4.8	Fences & Walls	Install decorative wall behind home & <del>rubbish surround</del>
2.3	Site Features & Plantings	Install brick steps, landing & patio at rear of home

Type or print the following:

Applicant **Randall & Heather Scott**

Mailing Address **218 N. East Street**

City **Raleigh** State **NC** Zip Code **27601**

Date \_\_\_\_\_ Daytime Phone **919-219-1044**

Email Address **rscott98@me.com**

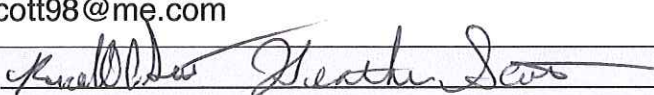
Signature of Applicant 

**Minor Work Approval (office use only)**

Upon being signed and dated below by the Planning Director or designee, this application becomes the Minor Work Certificate of Appropriateness. It is valid until \_\_\_\_\_. Please post the enclosed placard form of the certificate as indicated at the bottom of the card. Issuance of a Minor Work Certificate shall not relieve the applicant, contractor, tenant, or property owner from obtaining any other permit required by City Code or any law. Minor work projects not approved by staff will be forwarded to the Certificate of Appropriateness Committee for review at the next scheduled meeting.

Signature \_\_\_\_\_ Date \_\_\_\_\_

**Project Categories (check all that apply):**

- Exterior Alteration
- Addition
- New Construction
- Demolition

Will you be applying for state or federal rehabilitation tax credits for this project?

- Yes
- No

**(Office Use Only)**

Type of Work \_\_\_\_\_

*76, 35, 40*

*55, 33, 40*

**Design Guidelines** Please cite the applicable sections of the design guidelines ([www.rhdc.org](http://www.rhdc.org)). **Continued**

Section/Page	Topic	Brief Description of Work
2.3.5	Site Features & Plantings	Remove Severely Damaged Tree 8" in diameter
<del>2.6.6</del>	<del>Accessory Structures</del>	<del>Build Chicken Coop &amp; Run Behind Carriage House</del>
2.3	Site Features & Plantings	Move 3 fruit trees planted last year

TO BE COMPLETED BY APPLICANT	TO BE COMPLETED BY CITY STAFF				
	YES	N/A	YES	NO	N/A
<p>Attach 8-1/2 " x 11" sheets with written descriptions and drawings, photographs, and other graphic information necessary to completely describe the project. Use the checklist below to be sure your application is complete.</p> <p><b>Minor Work (staff review) – 1 copy</b></p> <p><b>Major Work (COA Committee review) – 13 copies</b></p>			✓		
1. <b>Written description.</b> Describe clearly and in detail the nature of your project. Include exact dimensions for materials to be used (e.g. width of siding, window trim, etc.)	<input checked="" type="checkbox"/>		✓		
2. <b>Description of materials</b> (Provide samples, if appropriate)	<input checked="" type="checkbox"/>		✓		
3. <b>Photographs</b> of existing conditions are required.	<input checked="" type="checkbox"/>		✓		
4. <b>Paint Schedule</b> (if applicable)	<input checked="" type="checkbox"/>	<input type="checkbox"/>	✓		
5. <b>Plot plan</b> (if applicable). A plot plan showing relationship of buildings, additions, sidewalks, drives, trees, property lines, etc., must be provided if your project includes any addition, demolition, fences/walls, or other landscape work. Show accurate measurements. You may also use a copy of the survey you received when you bought your property. Revise the copy as needed to show existing conditions and your proposed work.	<input checked="" type="checkbox"/>	<input type="checkbox"/>	✓		
6. <b>Drawings</b> showing proposed work <ul style="list-style-type: none"> <li><input checked="" type="checkbox"/> Plan drawings</li> <li><input checked="" type="checkbox"/> Elevation drawings showing the new façade(s).</li> <li><input checked="" type="checkbox"/> Dimensions shown on drawings and/or graphic scale.</li> <li><input type="checkbox"/> 8-1/2" x 11" reductions of full-size drawings. If reduced size is so small as to be illegible, make 8-1/2" x 11" snap shots of individual drawings on the big sheet.</li> </ul>	<input checked="" type="checkbox"/>	<input type="checkbox"/>	✓		
7. Stamped envelopes addressed to all property owners within 100 feet of property not counting the width of public streets and alleys. (Required for Major Work)	<input type="checkbox"/>	<input checked="" type="checkbox"/>			✓
8. <b>Fee</b> ( <a href="#">See Development Fee Schedule</a> )	<input checked="" type="checkbox"/>		✓		

Gutters: Repair and re-install existing gutter system. Replace with same as existing 4" painted metal downspouts installed in existing holes in existing water table. SW Westinghouse White paint color.

~~Garage: Add a working garage door to existing carport. See attached specs and drawing.~~

Accessory Structures: Replace Carriage House Roof & ~~Two Entry Doors & Hayloft Door.~~ Existing Entry doors & Hayloft door are not functioning and need replacement. Will replace with like materials and paint to match existing carriage house. SW7103 Whitetail: Roof needs complete replacement. Remove existing, badly damaged roof and replace with Coastal Metal Brand Color Loc 24 Gauge Kynar snap lock panels 1/34" x 18" over high temperature weather guard in Medium Bronze. Spec Sheet Attached.

Driveways & Parking: Request to change the material of the upper drive and parking area. Would like to install Delaware or similar grade decorative gravel. Dimensioned drawing and survey location attached.

Fences & Walls: Install decorative wall along rear entrance of home using treated lumber. Painted house trim color (SW Westinghouse White) 21" tall x 5' wide x 32' long with three 12" deep x 7" high steps leading to upper driveway using phoenix brick material in running bond pattern. ~~Rubbish fence proposed to hide HVAC units, recycling & trash bins.~~ See elevations for overall and individual component measurements.

Site Features & Plantings: Stoop at home rear entrance will be 4'x4' stepping down to two 3" wide x 12" deep steps. Patio below is 16' x 16' patio. Rear Stoop is 21" high stepping to ground level. Phoenix brick paver material in running bond pattern. See elevation drawings and survey location attached. Remove maple tree that was badly damaged in ice storm. See attached pictures 11" in diameter. Move 3 fruit trees (plum, apple, pear) planted last year. Move to orchard area behind carriage house.

~~Accessory structure: Build chicken coop and run as temporary structure using cedar siding and roofing and roosting boxes. Treated wood 6x6" posts set in the ground with packed dirt. See attached elevations and survey location and pictures.~~

\*Major work application to follow for all other future items.

minor work items:

- Patio #1, steps/landing
- Gravel Parking Pad & upper drive
- ~~Rubbish fence~~
- 21" tall wall & steps
- ~~Chicken coop & run~~
- move 3 fruit trees

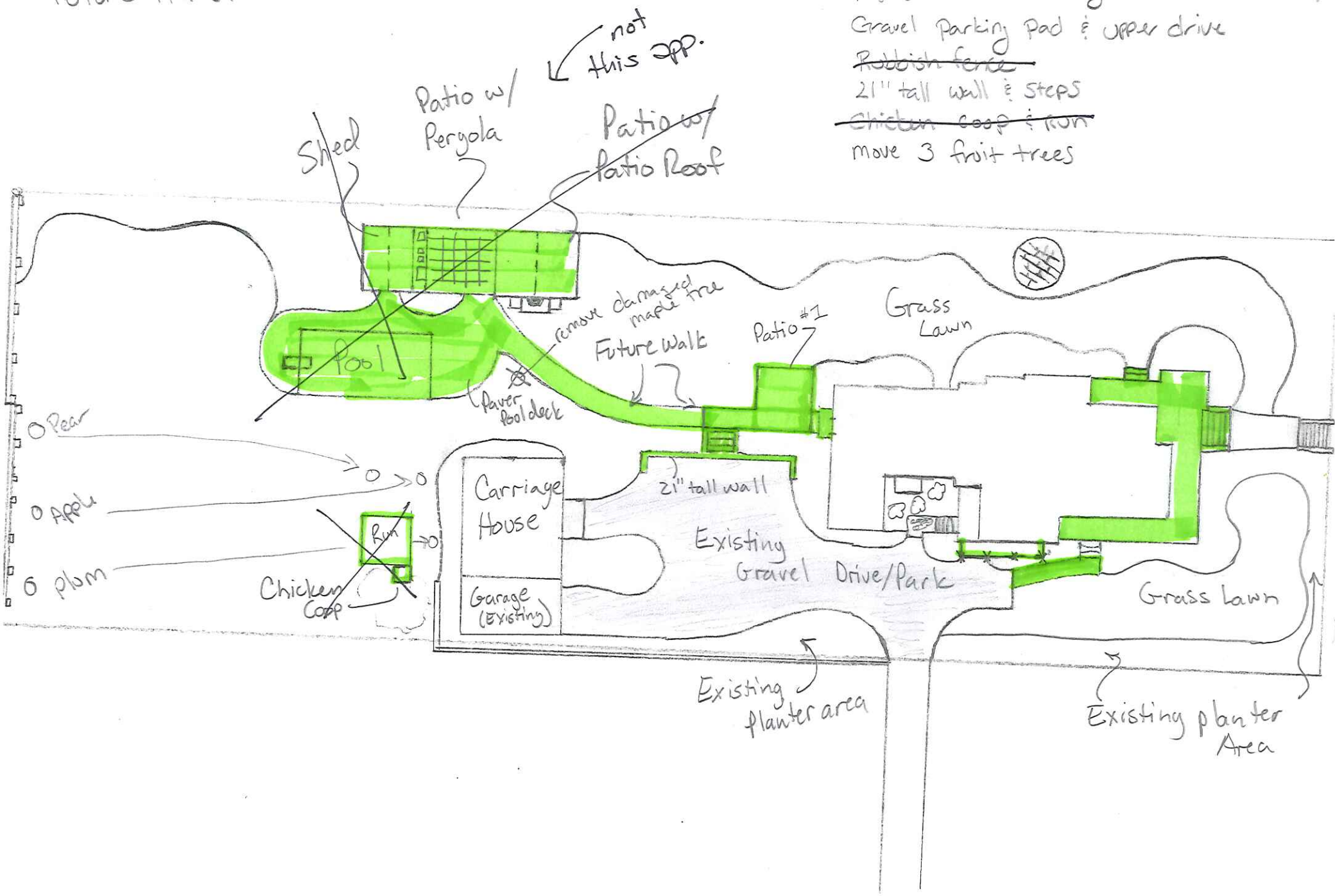

not this app.

- Pear
- Apple
- plm

~~Run~~  
~~Chicken Coop~~

Existing planter area

Existing planter Area

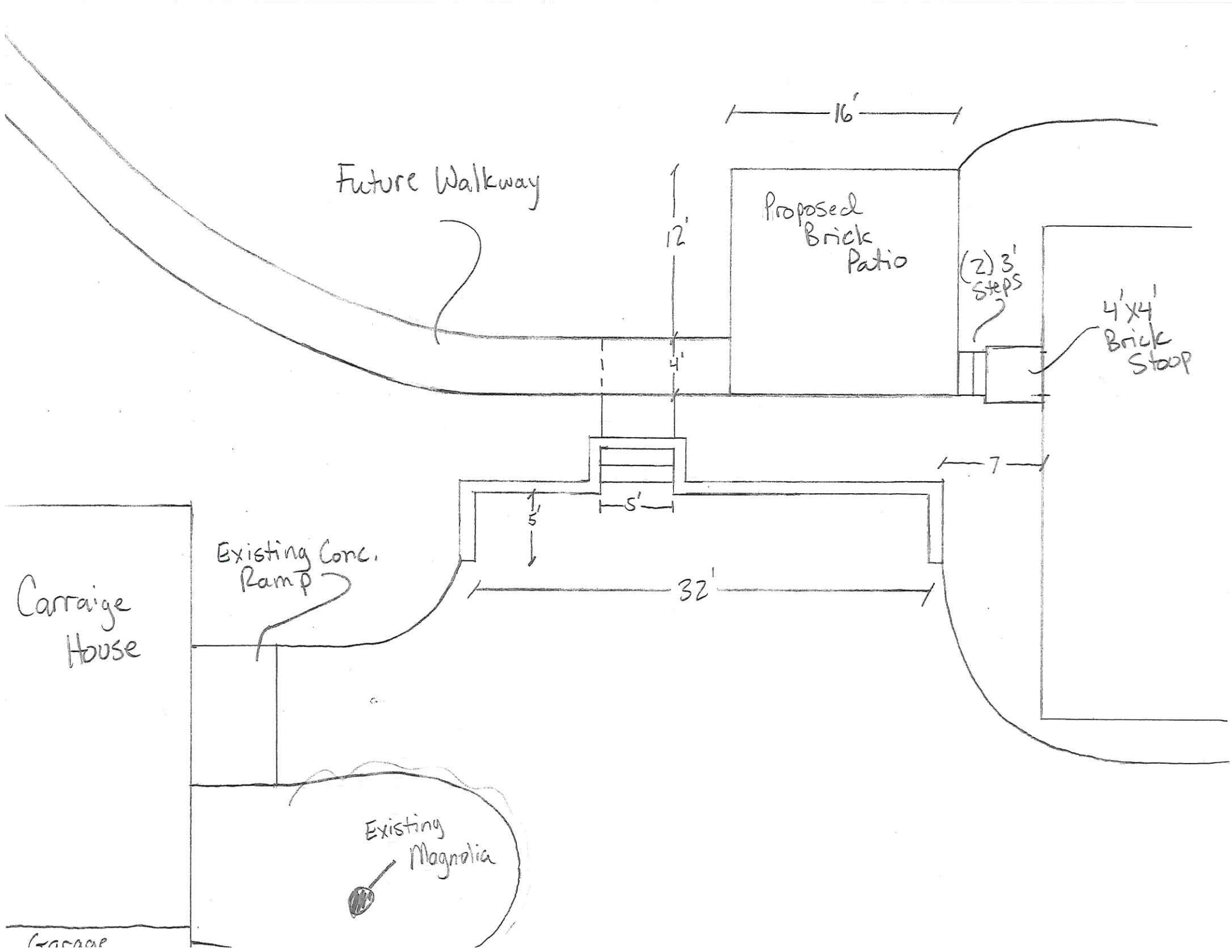

Future Walkway

16'

12'

4'

(2) 3'  
STEPS

4'x4'  
Brick  
Stoop

7'

5'

5'

32'

Carriage  
House

Existing Conc.  
Ramp

Existing  
Magnolia

Garage



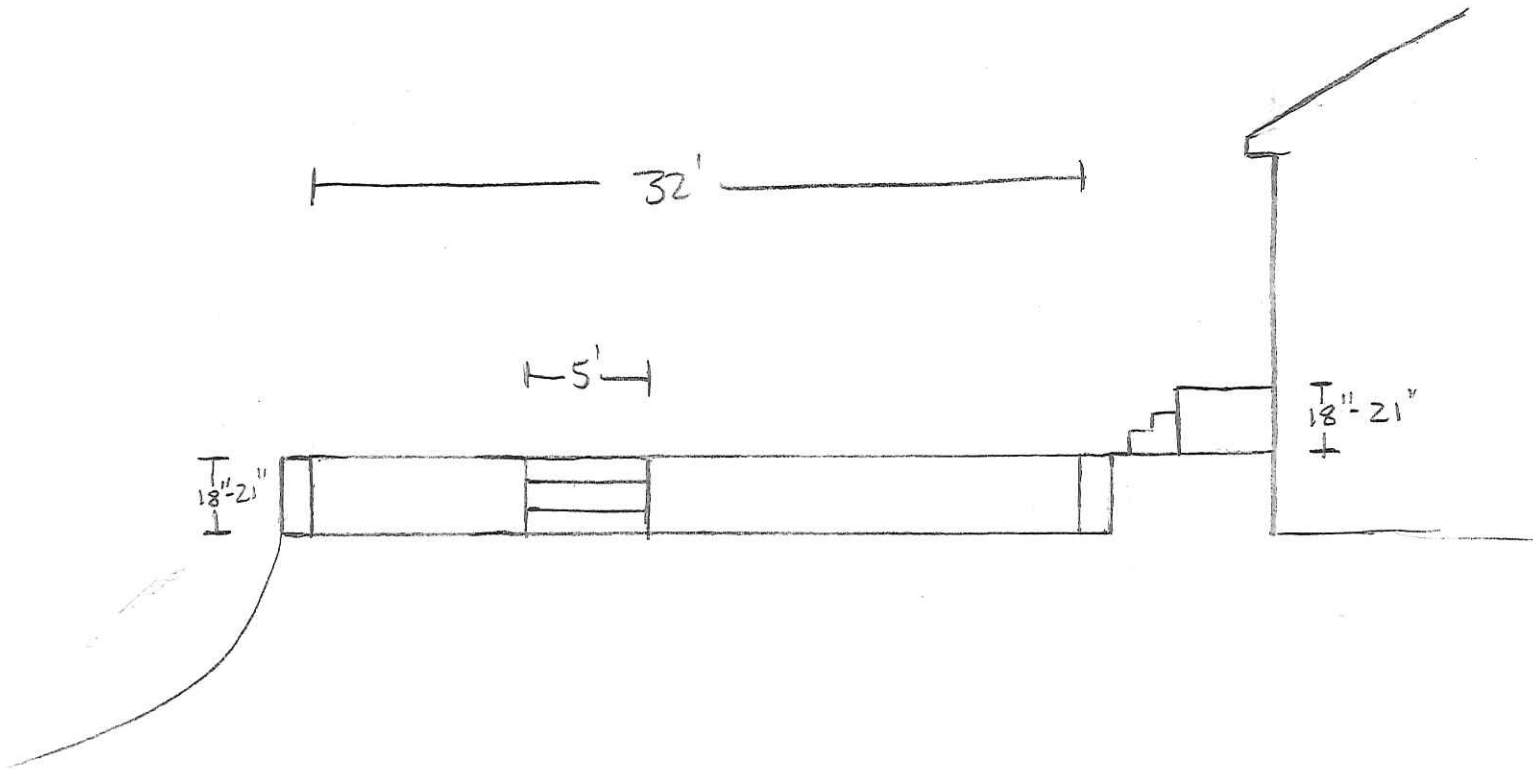

Parking wall & steps/landing elevation

# Coastal Metal Service

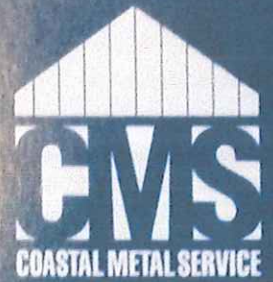

## COLOR LOC

24 Gauge Kynar 500. and Hylar 5000.



Classic Copper  
PREMIUM COLOR

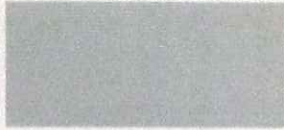

Silver Metallic  
PREMIUM COLOR



Ruby Red  
PREMIUM COLOR



Coastal White



Patina



Charcoal  
PREMIUM COLOR



Sand Stone



Sahara Tan



Beaufort Blue  
PREMIUM COLOR



Biscayne Blue  
PREMIUM COLOR



Stone Gray



Colonial Red



Dark Bronze



Hilton Head Green



Medium Bronze



Onyx Black



Acrylic Coated  
Galvalume

Coastal Metal Service  
Hwy. 117 North Bypass  
PO Box 128  
Goldsboro, NC 27533  
Phone: 888-267-6153  
Fax: 919-705-1097



Colors are represented  
as closely as possible.

If color match is critical,  
please request a  
physical sample.

## Products Available

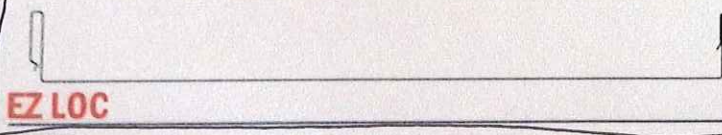

EZ LOC

NCR



CLASSIC BATTEN



LT 100

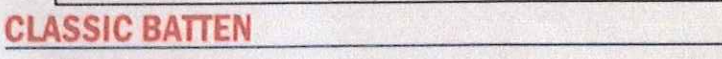

MS 16



HT 150



ULTRA 5V

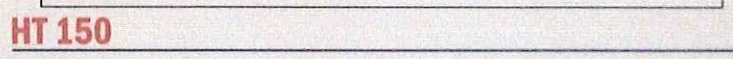

ULTRA RIB LOC



SS 24



VS 111

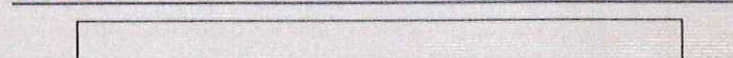

VS 12

Visit us online at [CoastalMetalService.com](http://CoastalMetalService.com)

Move three fruit trees from back wall to orchard/ coop-area behind carriage house.



Proposed orchard/ coop-area behind barn. Also see survey view.



Remove maple tree badly damaged in January ice storm.



Picture of area in-front of carriage house. Proposed upper drive and parking pad of decorative gravel. Gravel is already existing.



Picture of area in-front of carriage house. Proposed upper drive and parking pad of decorative gravel. Gravel is already existing. Rear of home will have brick steps, landing and patio, wall and steps leading down to decorative gravel upper drive and parking pad.



Proposed area to add decorative gravel. Gravel is existing but would like to upgrade to decorative Delaware or similar decorative grade gravel. Also see area proposed for rubbish fence. ?



Existing Carport to be finished and garage door added.



Replace Carriage House Roof.



Proposed chicken coop. Run to be added and moved behind carriage house as a temporary structure.



Proposed coop & run location. Also see survey







**From:** "Robinson, Simone" <[Simone.Robinson@raleighnc.gov](mailto:Simone.Robinson@raleighnc.gov)>

**Subject:** Minor Work Application - 218 N. East Street

**Date:** March 14, 2016 at 11:22:01 AM EDT

**To:** "[Hrose100@yahoo.com](mailto:Hrose100@yahoo.com)" <[Hrose100@yahoo.com](mailto:Hrose100@yahoo.com)>

**Cc:** "Tully, Tania" <[Tania.Tully@raleighnc.gov](mailto:Tania.Tully@raleighnc.gov)>, "Band, Daniel" <[Daniel.Band@raleighnc.gov](mailto:Daniel.Band@raleighnc.gov)>

Good Morning Randall:

Thank you for submitting a Minor Work application for 218 N. East Street. After reviewing your application I have a few comments. Additional materials may be submitted by email.

- Please submit a photo of the front of the house which includes the property and the house
- Garage: the application says that specs are provided for a door to add to the carport. These are not provided.
- Provide evidence of the existing gravel driveway/parking areas. Will the gravel have an edging?
- Provide gravel sample

- Accessory Structure: application says like materials, but not design. Provide detailed information on the new doors. Provide evidence that the doors need replacing as opposed to repairing
- Barn roof: provide specs on the ridge cap; also - a lower seam height would be more appropriate
- Is the decorative "wall" proposed at the rear entrance a retaining wall? If so it needs to be of some kind of masonry. Wood walls atypical of the district.
- Provide a patio paver sample
- What are the overall dimensions of the chicken coop with run?
- Provide a detailed drawing of the proposed rear and side steps
- What does the green highlight mean on the site plan?
- Provide a revised overall site plan that only shows items requested in this application. This needs to be either scaled or have dimensions.
- Are you planning to replace the damaged maple tree that you intend to remove? If not, a Major Work application is required for its removal.
- The proposed HVAC screening fence is a Major Work item. Staff can only approved fences 42" or lower

Please let me know if you have any questions.

Thanks,

Simone Robinson, Planner I  
 Long Range Planning Division  
 Raleigh City Planning Department  
 (919) 996-2638

“E-mail correspondence to and from this address may be subject to the North Carolina Public Records Law and may be disclosed to third parties by an authorized City or Law Enforcement official.”



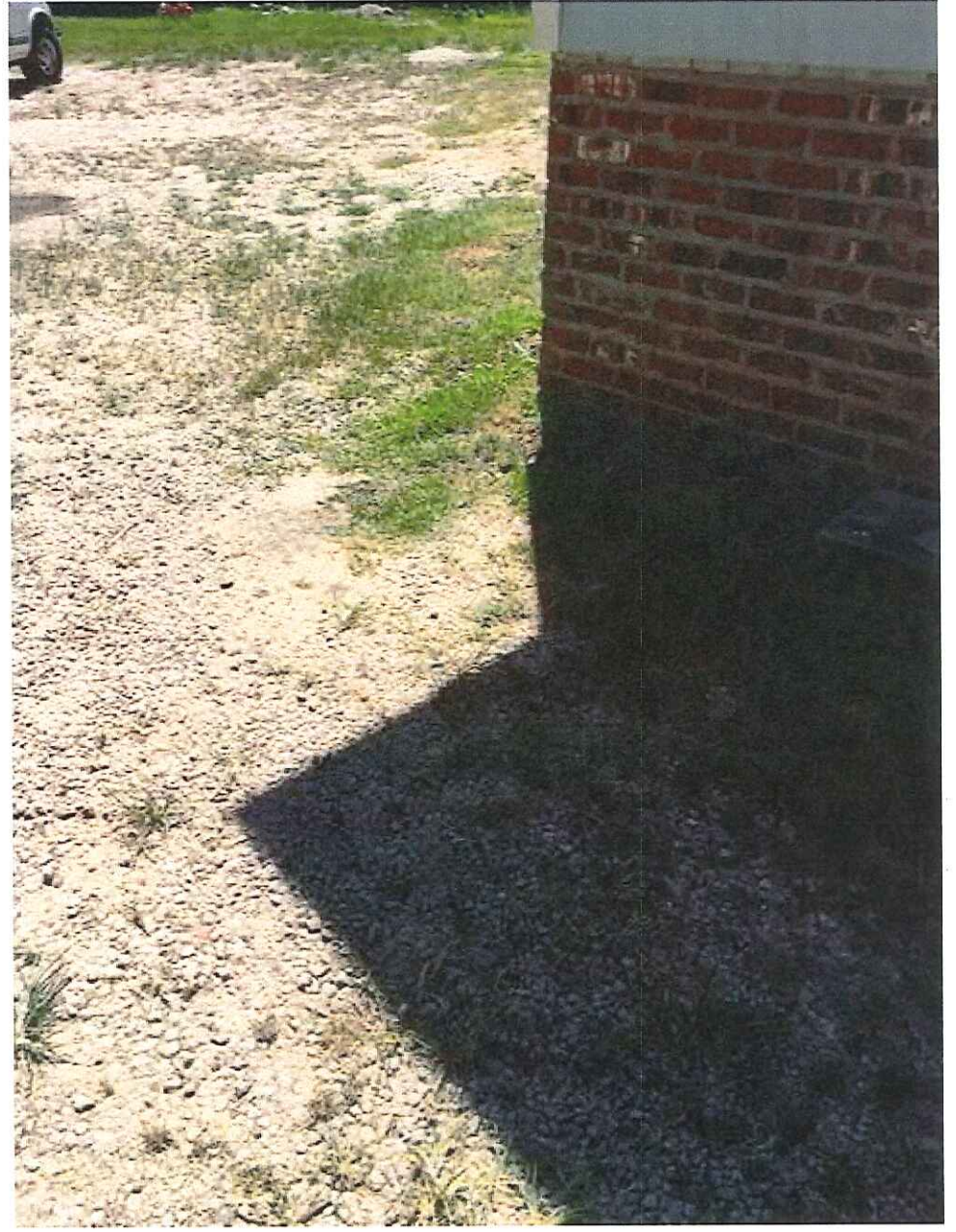

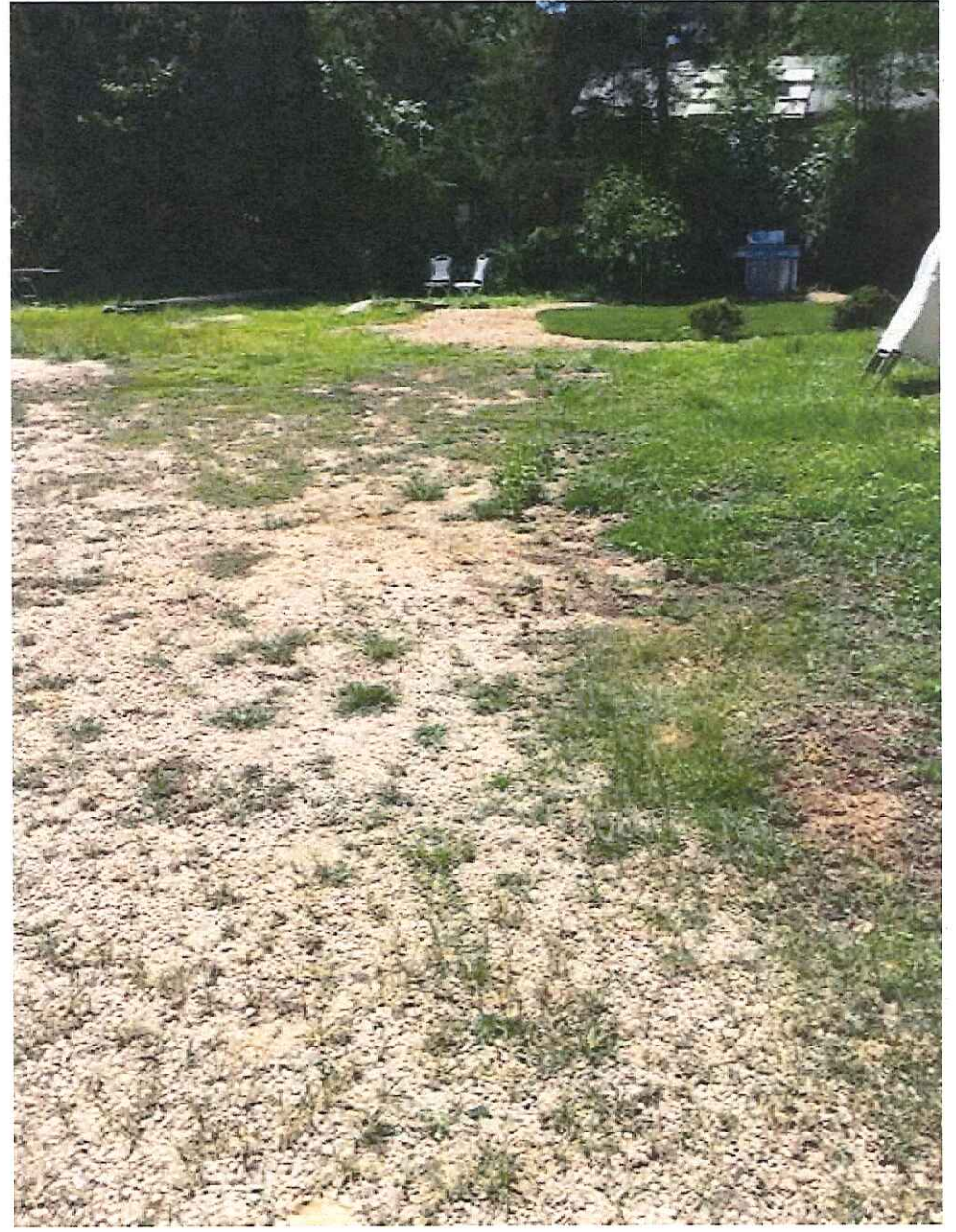
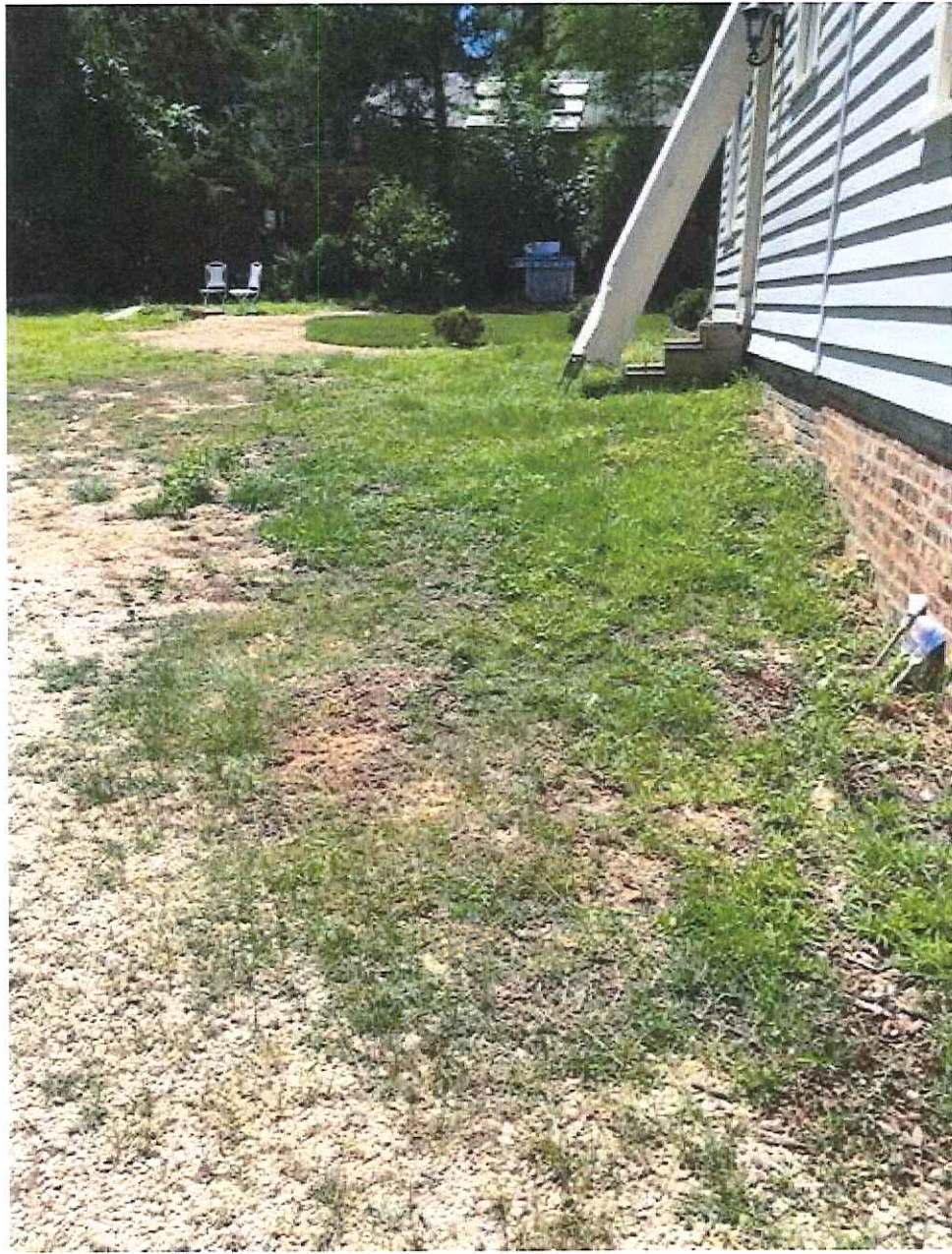

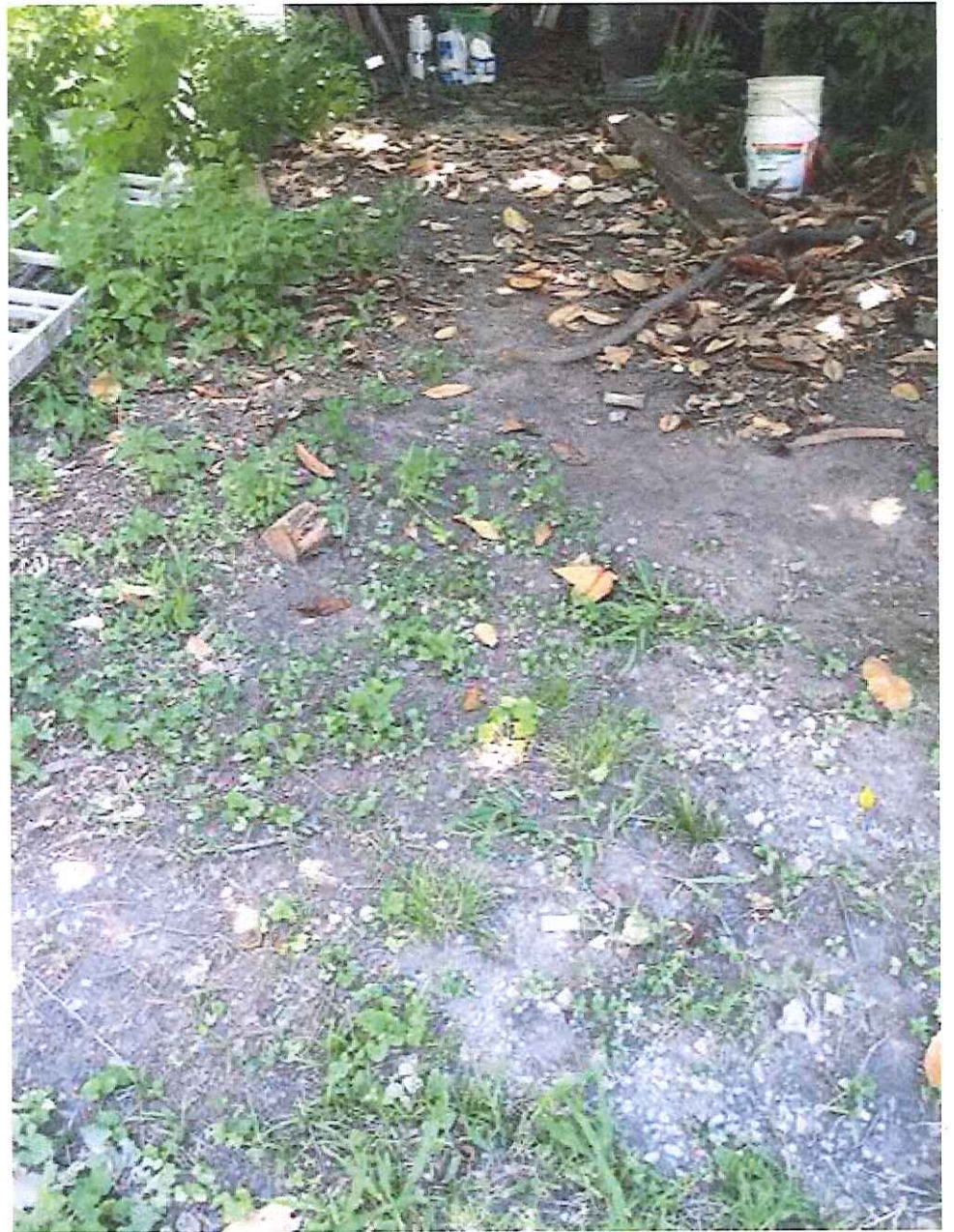

# Coastal Metal Service



## COLOR LOC

24 Gauge Kynar 500® and Hylar 5000®

Coastal Metal Service  
 Goldsboro, NC  
 888-276-6153



Classic Copper  
 PREMIUM COLOR

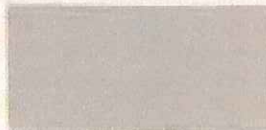

Silver Metallic



Ruby Red



Coastal White



Patina



Charcoal



Sand Stone



Sahara Tan



Biscuit Blue



Biscayne Blue

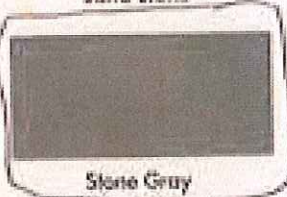

Stone Gray



Colonial Red



Dark Bronze



Hilton Head Green



Medium Bronze



Onyx Black



Acrylic Coated Galvalume



Colors are represented  
 as closely as possible.

If color match is critical,  
 please request a  
 physical sample.

*Amended color  
 8/19/16*

*See 9/20/19  
 Amended Profile*

### Products Available

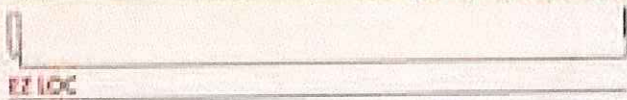

EZ LOC

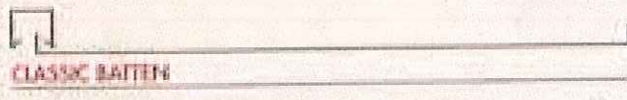

CLASSIC BATTEN

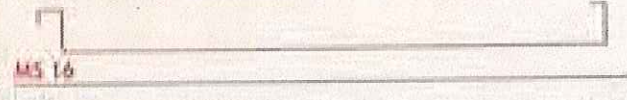

MS 16

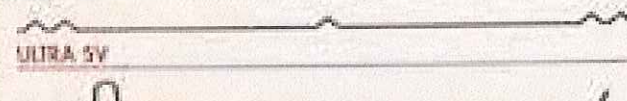

ULTRA 5V

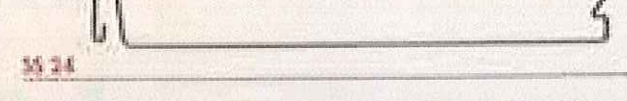

SS 24

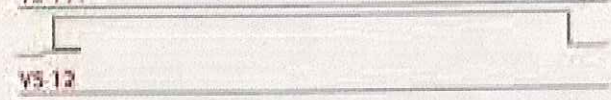
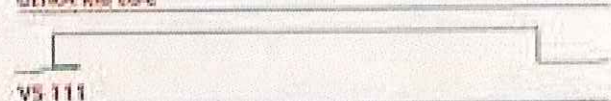
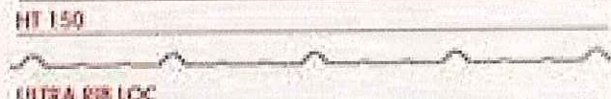
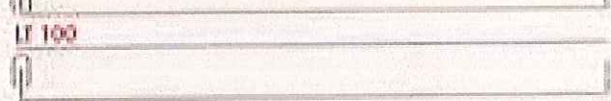
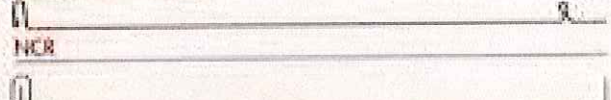

Visit us online at [CoastalMetalService.com](http://CoastalMetalService.com)

## Tully, Tania

---

**From:** Tully, Tania  
**Sent:** Monday, September 12, 2016 12:29 PM  
**To:** 'Heather Scott'  
**Subject:** RE: Minor Work Application - 218 N. East Street

Hi Heather –

I've amended the application based on your email and reviewed the documentation. I have the following comments and questions:

1. Gravel: What do you mean by “decorative” gravel. Depending on the color and appearance and based on recent decisions in Boylan Heights, this may not meet the guidelines. Throughout the historic districts, when gravel has been used as a driveway treatment, the traditional material used has been crushed gravel with flat faces and irregular edges.
2. Metal roof: The ridge cap specs are still needed as well as clarification on the new seam height. All I see from the attached detail is a color change.
3. Parking wall: The drawings do not have a sufficient level of detail. Please provide the bond pattern, top of wall treatment, dimensions, etc.. A larger scale drawing and/or section drawing is recommended.
4. Tree replacement: Where is the new Oak proposed to be planted?
5. Brick steps at patio: The drawings do not have a sufficient level of detail. A larger scale drawing and/or section drawing is recommended

I look forward to receiving the additional information.

Best,  
Tania

Tania Georgiou Tully, Planner II  
Historic Preservation  
Urban Design Center  
919.996.2674  
919.516.2684 (fax)  
[tania.tully@raleighnc.gov](mailto:tania.tully@raleighnc.gov)

COA process information is available [here](#).

---

**From:** Tully, Tania  
**Sent:** Friday, August 19, 2016 5:30 PM  
**To:** 'Heather Scott'  
**Subject:** RE: Minor Work Application - 218 N. East Street

Thanks Heather –

The Major has already been advertised so I'll amend the Minor based on this email and add it back in the queue. No need to resubmit samples.

-Tania



# Amendment

**Tully, Tania**

---

**From:** Heather Scott <hrose100@yahoo.com>  
**Sent:** Friday, August 19, 2016 1:17 PM  
**To:** Tully, Tania  
**Subject:** Fwd: Minor Work Application - 218 N. East Street  
**Attachments:** Scan 6.pdf; Scan 7.pdf

**Follow Up Flag:** Flag for follow up  
**Due By:** Monday, August 22, 2016 9:00 AM  
**Flag Status:** Flagged

Hi Tania,

Thank you for your message this week. I owe you the requested information below but we are changing a few things. If you would prefer we roll these into the major work session let me know and I'll send the materials today.

I've attached the requested picture of the front of the house including the property ✓

☐ Pictures of existing gravel in driveway/ parking areas attached. The gravel will not have an edging. I'll drop a sample by.

We've decided not to go through with the chicken coop and would like to remove that request ✓

We've not decided on a garage door and would like to remove this request ✓

We would like to remove new barn doors from the application ✓

Please see attached roof spec. Per Simone's advice, we've revised to a lower seem height.

☐ The decorative parking wall is not a retaining wall. We've proposed to use the phoenix brick in the application.

I've attached drawings of rear steps and wall.

The pavers are the same Phoenix we've used at a few properties. Should I drop another sample by? — NO

We are replacing the damaged maple tree with an oak

We've proposed the HVAC fence as a major work so this may also be removed. ✓

Please let me know what else I'll need to provide. Thanks so much.

Heather Scott  
919-219-1044

"decorative"  
unlikely to meet gl

→ great. ~~spec~~  
location?

provide new  
specs. Only see  
color change.

drawings not  
of sufficient level of  
detail. Need to know  
bond pattern/top treatment/dimensions, etc...

## Tully, Tania

---

**From:** Heather Scott <hrose100@yahoo.com>  
**Sent:** Tuesday, September 20, 2016 6:23 PM  
**To:** Tully, Tania  
**Subject:** Re: Minor Work Application - 218 N. East Street  
**Attachments:** 218 Backyard Major003.pdf; Maple Tree.pdf

Hello,

Thank you for amending the application.

*no photo.  
if also okay. OK*

1. I've attached a picture of the gravel I would like to use. Let me know if it looks like the approvable type. It is crushed with irregular sides. I've seen it in a few places in Oakwood.

2. The new, proposed seam height for the 5V is 7/16" high ribs on 12 inch centers. Screen-shot of website spec drawing attached. The ridge cap is the Coastal Metal Service Classic Ridge Cap (specs attached)

3. Please see attached parking wall drawings that include required level of detail.

4. Please see attached survey for location of replacement tree. Would like to change species to Japanese Maple.

5. Please see attached drawings for rear steps & patio which include required level of detail.

Thank you! Let me know if I can send anything further.

Sincerely,

Heather Scott

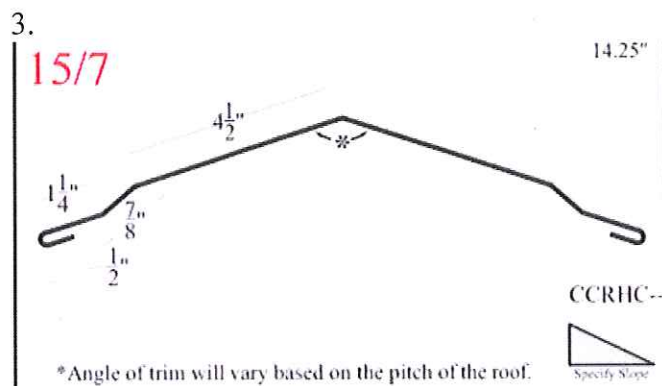

## 5V Profile

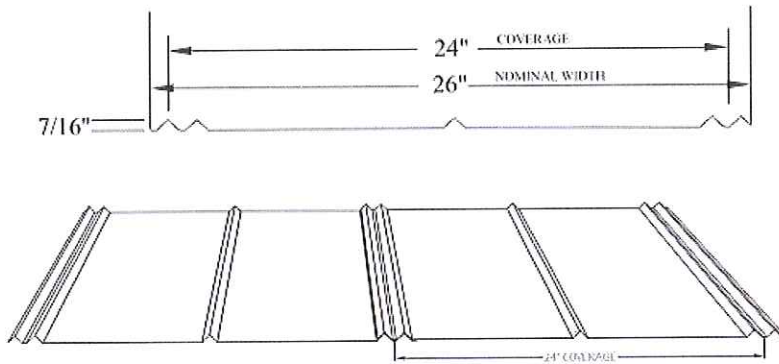

On Sep 12, 2016, at 12:29 PM, Tully, Tania <[Tania.Tully@raleighnc.gov](mailto:Tania.Tully@raleighnc.gov)> wrote:

Hi Heather –

I've amended the application based on your email and reviewed the documentation. I have the following comments and questions:

1. Gravel: What do you mean by "decorative" gravel. Depending on the color and appearance and based on recent decisions in Boylan Heights, this may not meet the guidelines. Throughout the historic districts, when gravel has been used as a driveway treatment, the traditional material used has been crushed gravel with flat faces and irregular edges.
2. Metal roof: The ridge cap specs are still needed as well as clarification on the new seam height. All I see from the attached detail is a color change.
3. Parking wall: The drawings do not have a sufficient level of detail. Please provide the bond pattern, top of wall treatment, dimensions, etc.. A larger scale drawing and/or section drawing is recommended. -
4. Tree replacement: Where is the new Oak proposed to be planted?
5. Brick steps at patio: The drawings do not have a sufficient level of detail. A larger scale drawing and/or section drawing is recommended

I look forward to receiving the additional information.

Best,  
Tania

Tania Georgiou Tully, Planner II  
Historic Preservation  
Urban Design Center  
919.996.2674  
919.516.2684 (fax)  
[tania.tully@raleighnc.gov](mailto:tania.tully@raleighnc.gov)

COA process information is available [here](#).

Entire top of wall will be  
Rowlock  
Pattern

Entire vertical surface will  
be running bond pattern  
including steps

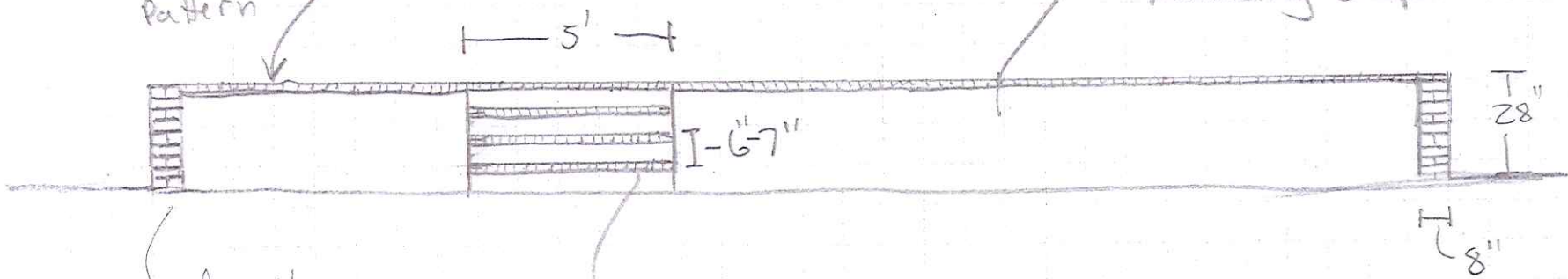

End wall  
is running bond

Each Step will be  
Rowlock Bond on top.  
Vertical surface of  
Step will be running bond

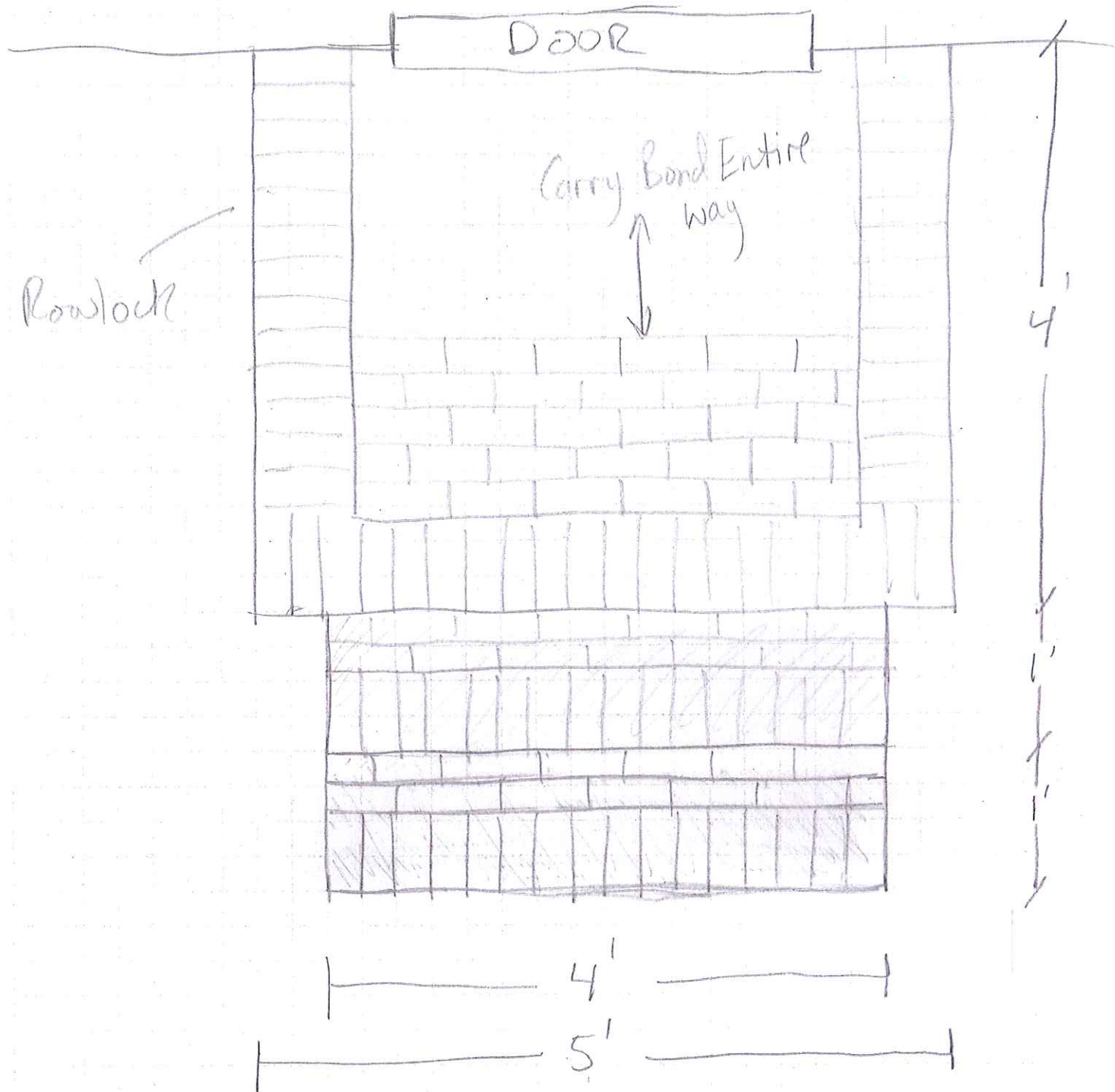

# TOP VIEW

Patio/Walkway

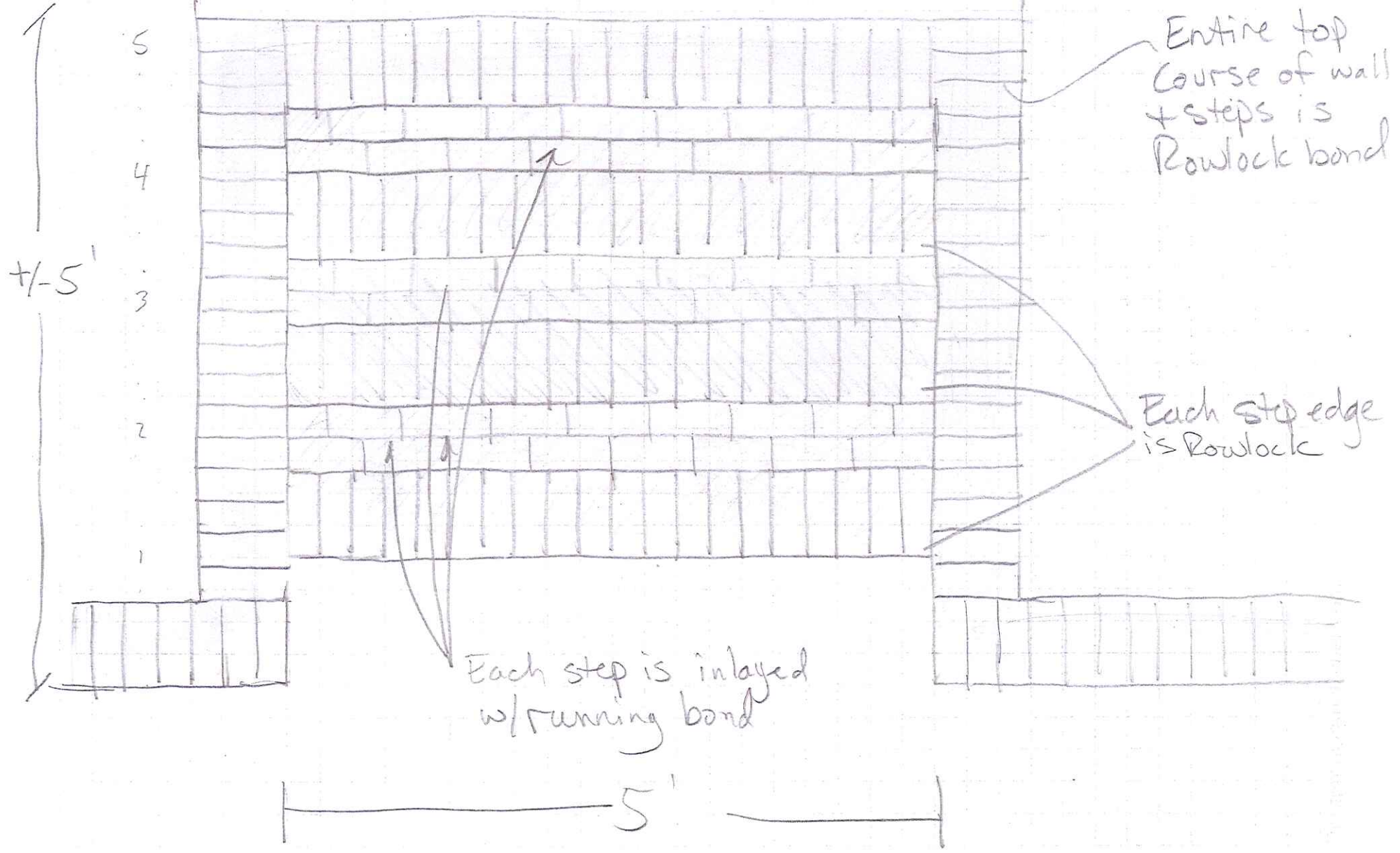

Entire top course of wall + steps is Rowlock bond

Each step edge is Rowlock

Each step is inlaid w/ running bond

+/- 5'

5'

Proposed location to plant replacement Japanese Maple.

