



CERTIFICATE OF APPROPRIATENESS PLACARD

for Raleigh Historic Resources

403 ELM STREET

Address

OAKWOOD

Historic District

Historic Property

010-14-MW

Certificate Number

2/7/2014

Date of Issue

11/6/2013

Expiration Date

Project Description:

- Remove and rebuild rear balcony in same configuration;
- relocate and add new windows on rear and rear side elevation;
- expand size of rear deck;
- add patio doors on rear elevation;
- remove rear utility chimney

OK to PERMIT

This card must be kept pasted in a location within public view until all phases of the described project are complete. The work must conform with the code of the City of Raleigh and laws of the state of North Carolina. When your project is complete, you are required to ask for a final zoning inspection in a historic district area. Telephone the RHDC office at 832-7238 and commission staff will coordinate the inspection with the Inspections Department. If you do not call for this final inspection, your Certificate of Appropriateness is null and void.

Signature, 
Raleigh Historic Development Commission



Planning & Development

Customer Service Center
One Exchange Plaza
1 Exchange Plaza, Suite 400
Raleigh, North Carolina 27601
Phone 919-996-2495
eFax 919-996-1831

Raleigh Historic Development Commission – Certificate of Appropriateness (COA) Application



- Minor Work (staff review) – 1 copy
- Major Work (COA Committee review) – 13 copies
 - Most Major Work Applications
 - Additions Greater than 25% of Building Square Footage
 - New Buildings
 - Demo of Contributing Historic Resource
- Post Approval Re-review of Conditions of Approval

For Office Use Only

Transaction # 387188
 File # 010-14 MW
 Fee \$ 28.00
 Amt Paid \$ 28.00
 Check # 112
 Rec'd Date 1/30/14
 Rec'd By AKW

If completing by hand, please use BLACK INK. Do not use blue, red, any other color, or pencil as these do not photocopy.

Property Street Address 403 Elm St

Historic District Oakwood

Historic Property/Landmark name (if applicable)

Owner's Name Michiel Doorn

Lot size 3,663 sf

(width in feet) 37

(depth in feet) 99

For applications that require review by the COA Committee (Major Work), provide addressed, stamped envelopes to owners of all properties within 100 feet (i.e. both sides, in front (across the street), and behind the property) not including the width of public streets or alleys:

Property Address	Property Address

I understand that all applications that require review by the commission's Certificate of Appropriateness Committee must be submitted by 4:00 p.m. on the application deadline; otherwise, consideration will be delayed until the following committee meeting. An incomplete application will not be accepted.

Type or print the following:

Applicant **Michiel Doorn**

Mailing Address **403 Elm St**

City **Raleigh** State **NC** Zip Code **27604**

Date **1/29/2014** Daytime Phone _____

Email Address **michiel.doorn@me.com**

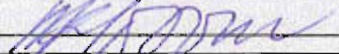
Signature of Applicant 

Minor Work Approval (office use only)

Upon being signed and dated below by the Planning Director or designee, this application becomes the Minor Work Certificate of Appropriateness. It is valid until 8/7/14. Please post the enclosed placard form of the certificate as indicated at the bottom of the card. Issuance of a Minor Work Certificate shall not relieve the applicant, contractor, tenant, or property owner from obtaining any other permit required by City Code or any law. Minor work projects not approved by staff will be forwarded to the Certificate of Appropriateness Committee for review at the next scheduled meeting.

Signature  Date 8/7/14

w/notes

Project Categories (check all that apply):

Exterior Alteration

Addition

New Construction

Demolition

Will you be applying for state or federal rehabilitation tax credits for this project?

Yes

No

(Office Use Only)

Type of Work _____

84, 30, 85, 57,

24, 22,

Design Guidelines Please cite the applicable sections of the design guidelines (www.rhdc.org).

Section/Page	Topic	Brief Description of Work
Sect 3.6/p37	Exterior Walls	Exterior alteration will be relegated to the addition - not historic structure
Sect 3.7/p39	Windows + Doors	Windows that are being removed and/or moved are not historic fabric of the house
Sect 3.7/p39	Windows + Doors	All new windows and doors to be of all wood material consistent with the existing house
Sect 3.8/p43	Entrances + Porches	we are proposing to demo two story deck structure and rebuild it back to the way it was before but structurally sound
		the decks and details are not part of the historic fabric of the house, but will be built back

TO BE COMPLETED BY APPLICANT			CITY STAFF		
	YES	N/A	YES	NO	N/A
<p>Attach 8-1/2" x 11" sheets with written descriptions and drawings, photographs, and other graphic information necessary to completely describe the project. Use the checklist below to be sure your application is complete.</p> <p>Minor Work (staff review) – 1 copy</p> <p>Major Work (COA Committee review) – 13 copies</p>			✓		
1. Written description. Describe clearly and in detail the nature of your project. Include exact dimensions for materials to be used (e.g. width of siding, window trim, etc.)	<input checked="" type="checkbox"/>		✓		
2. Description of materials (Provide samples, if appropriate)	<input checked="" type="checkbox"/>		✓		
3. Photographs of existing conditions are required.	<input checked="" type="checkbox"/>		✓		
4. Paint Schedule (if applicable)	<input type="checkbox"/>	<input type="checkbox"/>			
5. Plot plan (if applicable). A plot plan showing relationship of buildings, additions, sidewalks, drives, trees, property lines, etc., must be provided if your project includes any addition, demolition, fences/walls, or other landscape work. Show accurate measurements. You may also use a copy of the survey you received when you bought your property. Revise the copy as needed to show existing conditions and your proposed work.	<input type="checkbox"/>	<input type="checkbox"/>		✓	
6. Drawings showing proposed work <ul style="list-style-type: none"> <input type="checkbox"/> Plan drawings <input type="checkbox"/> Elevation drawings showing the new façade(s). <input type="checkbox"/> Dimensions shown on drawings and/or graphic scale. <input type="checkbox"/> 8-1/2" x 11" reductions of full-size drawings. If reduced size is so small as to be illegible, make 8-1/2" x 11" snap shots of individual drawings on the big sheet. 	<input checked="" type="checkbox"/>	<input type="checkbox"/>	✓		
7. Stamped envelopes addressed to all property owners within 100 feet of property not counting the width of public streets and alleys. (Required for Major Work)	<input type="checkbox"/>	<input checked="" type="checkbox"/>			✓
8. Fee (See Development Fee Schedule)	<input checked="" type="checkbox"/>		✓		

403 Elm Street Description of Work

Records show that this 3 bedroom house was originally built in 1923. A 2-story addition was constructed at the rear of the house in 1950, which includes the kitchen on the first floor and a utility/ laundry room on the second floor. The rear deck and balcony above are also shown as being built at this time.

The homeowners plan on renovating the kitchen, dining room, utility room, bathrooms, and bedrooms of the current home. The majority of the exterior alterations made to 403 Elm will occur on the rear (West) elevation of the house facing the back yard:

The renovation calls for several windows to be added to the current facade. The rear elevation now features one double hung wood window in the kitchen and another double hung window directly above in the existing upstairs utility room. The downstairs window from the rear (West) elevation will be relocated to the upstairs side (North) elevation. This relocation will create a balanced composition on the North elevation and will allow light into the new upstairs space from the side of the house.

The upstairs double hung window seen on the rear elevation will be replaced with two smaller double hung windows with an 8" mullion in between. The window length will be shortened to accommodate an interior window seat in this space. See attached drawings and photos for clarity.

Downstairs, a pair of full lite patio doors will replace the opening where the existing kitchen window is now located. A final change to the windows on this elevation will be a new window which will be placed in the blank wall under the balcony. This window will allow a view from the front of the house to the back yard upon entry.

The ground floor deck and the upstairs balcony are in extremely poor condition due to neglect and water damage since their construction in circa 1950. These elements will be demolished and then rebuilt and will keep a similar appearance and character as the existing. The deck will be slightly expanded to meet the new french doors of the kitchen renovation (shown in proposed elevation drawing). Additionally, the adjacent portions of the foundation require structural improvement for the stability of the home. Removing the existing deck/ balcony is essential to gaining access to the damaged foundation.

A final request for change involves the chimney located in the 1950 addition. The owners would like to have this brick structure removed so that they can utilize the limited space around the chimney. Exterior elevations will not be affected by the chimney's removal besides the portion that protrudes from the roof. This is not seen from the street side of the house.



This image displays the condition of house from the West elevation, taken from the back yard. We are proposing to move the existing ground level window upstairs to the North elevation (side) of the house. This window will be placed in the remodeled rear second floor area . It will be located directly above another existing window in the kitchen, creating a balanced elevation on the side of the house (see attached proposed elevation drawings).

The downstairs window shown in the image to the left will be replaced with pair of full lite french doors which will open out to a newly expanded deck. A final new window to be added on the rear ground level will be located under the existing balcony. This will allow a visual connection from the front door to the back yard upon entry to the main foyer of the house.

Images below show more information about the house, including: overall condition of the house, evidence of the 1950s addition, existing and proposed window locations, and utility chimney.

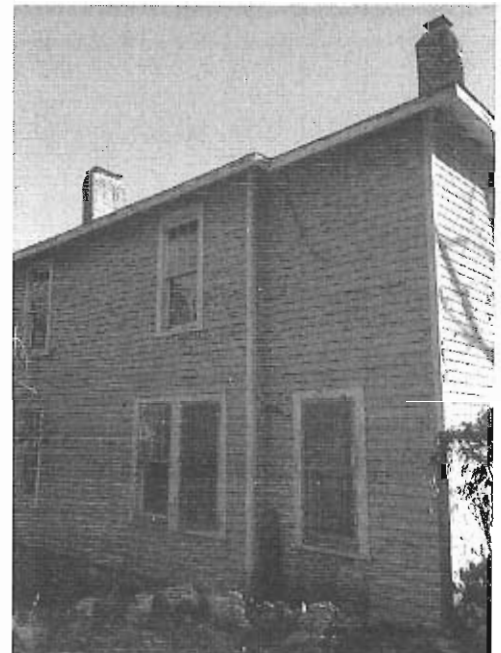
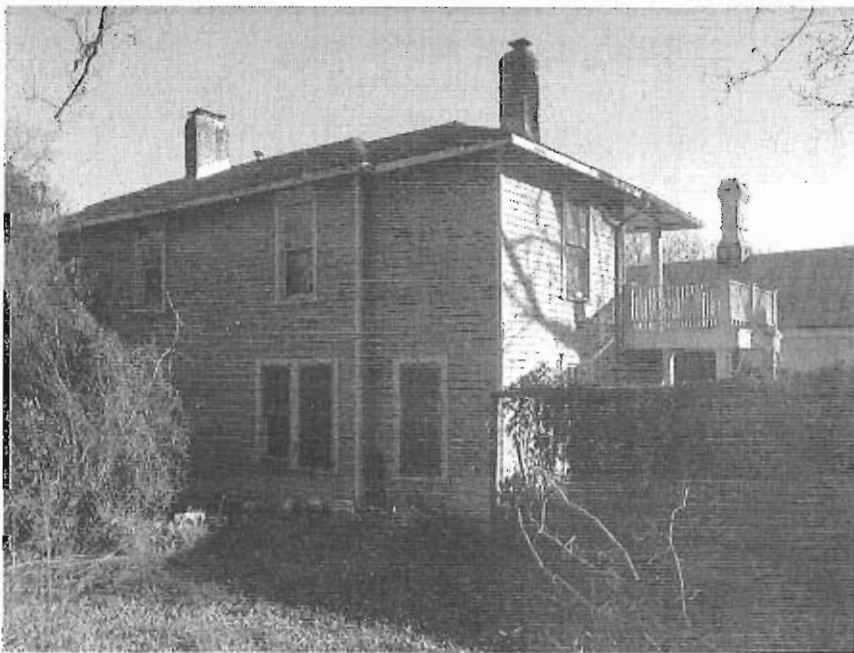



We are also proposing to demolish and then re-construct the 2-story deck and the entire balcony structure in order to return this element of the house to useable condition. Due to years of neglect and water damage, the deck and balcony structure have sustained serious deterioration. These elements will be rebuilt and will keep a similar appearance and character as the existing. The deck will be slightly expanded to meet the new french doors of the kitchen renovation (shown in proposed elevation drawing).

Additionally, the adjacent portions of the foundation require structural improvement for the stability of the home. Removing the existing deck/ balcony is essential to gaining access to the damaged foundation. Images here show details of deck/ balcony damage.

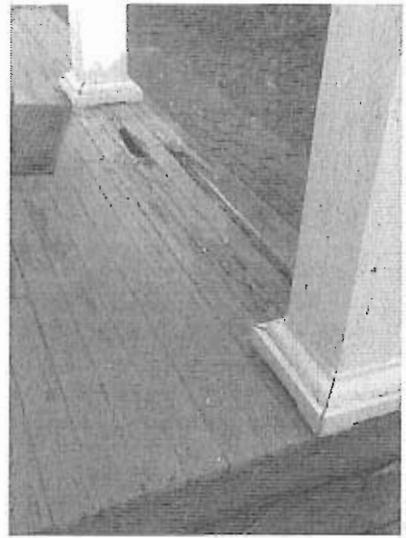

The window in the left picture will be relocated to the upstairs utility room, which is shown in the picture on the right. The window will be placed where the shelves currently exist.

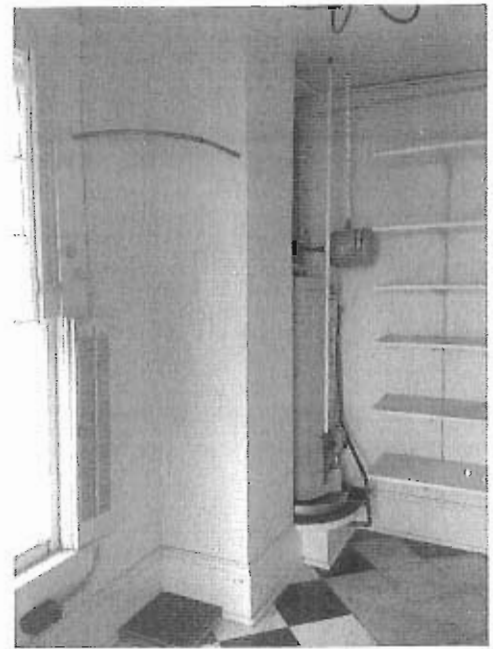
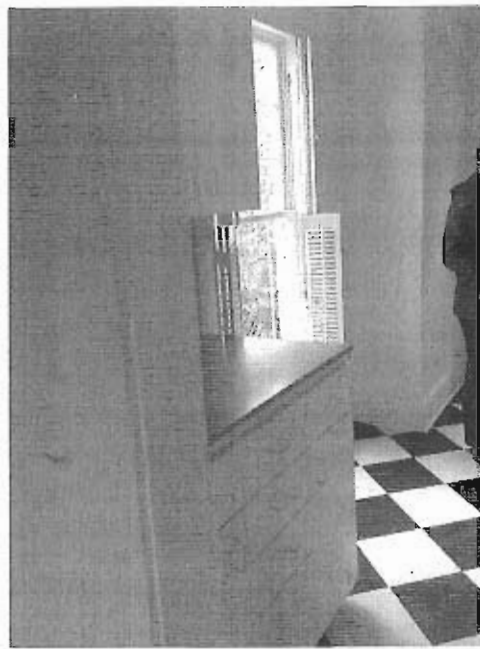

All images on this page show the plastered utility chimney flue which the owners wish to have removed. The chimney does not impact the elevations of the house except for the portion that protrudes from the roof. This cannot be seen from the street side of the home. The checker patterned floor marks the 1950s addition to the house.

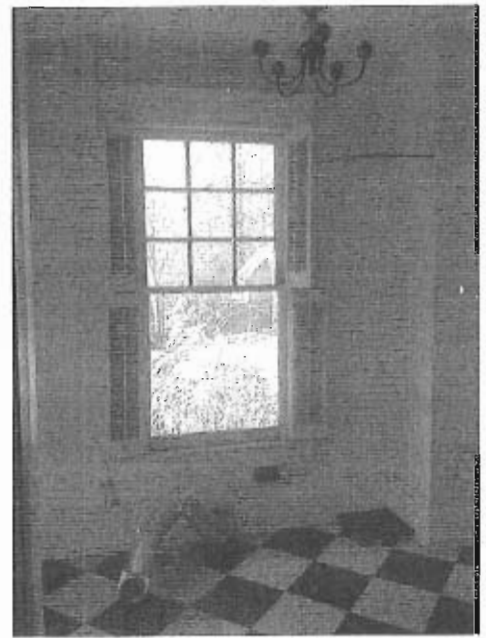
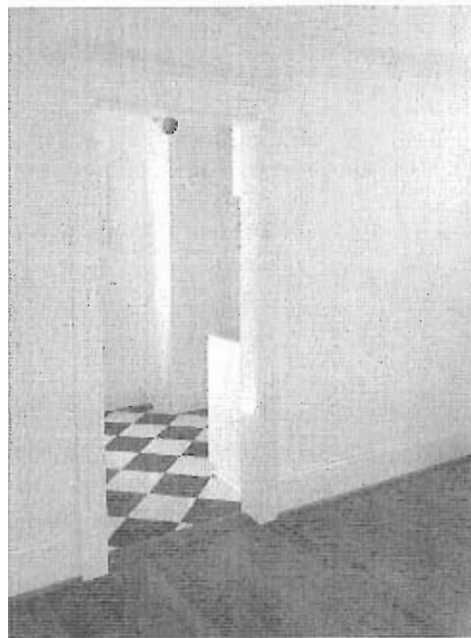

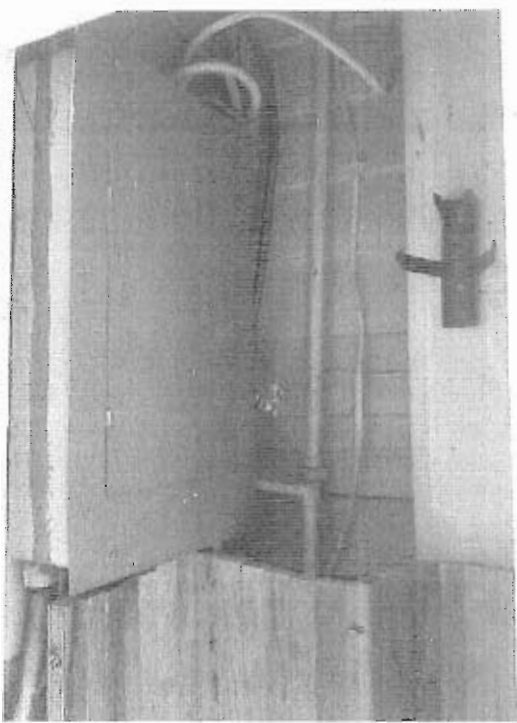

The siding shown here is located within the envelope of the existing kitchen, which supports that the kitchen is indeed an addition to the original structure.



Current perspective from front entry of house. New window will be located at back wall of hallway and will connect the front of the house to a view of the back yard.



Existing North Elevation

Scale - 1/8" = 1'-0"

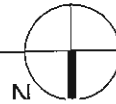

PELL ST studio

Architect
Ashley Hankel Morris
306 Pell Street
Raleigh, NC 27604
919.696.0970



Former rear kitchen window
is relocated to this location

PELL ST studio

Architect
Ashley Henkel Morris
306 Pell Street
Raleigh, NC 27604
919.696.0970

Proposed North Elevation

Scale - 1/8" = 1'-0"





Existing West Elevation

Scale - 1/8" = 1'-0"

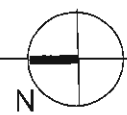

PELL ST studio

Architect
Ashley Henkel Morris
306 Pell Street
Raleigh, NC 27604
919.696.0970

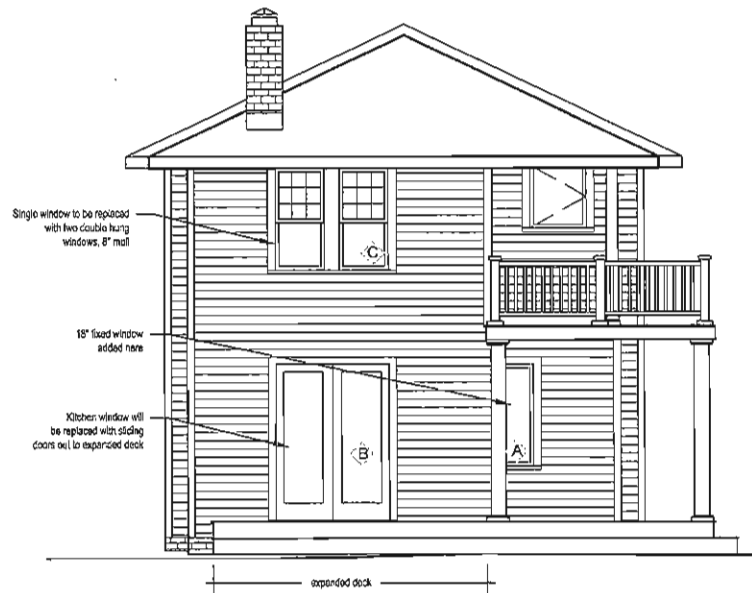

Proposed West Elevation

Scale - 1/8" = 1'-0"



PELL ST studio

Architect
 Ashley Henkel Morris
 306 Pell Street
 Raleigh, NC 27604
 919.696.0970

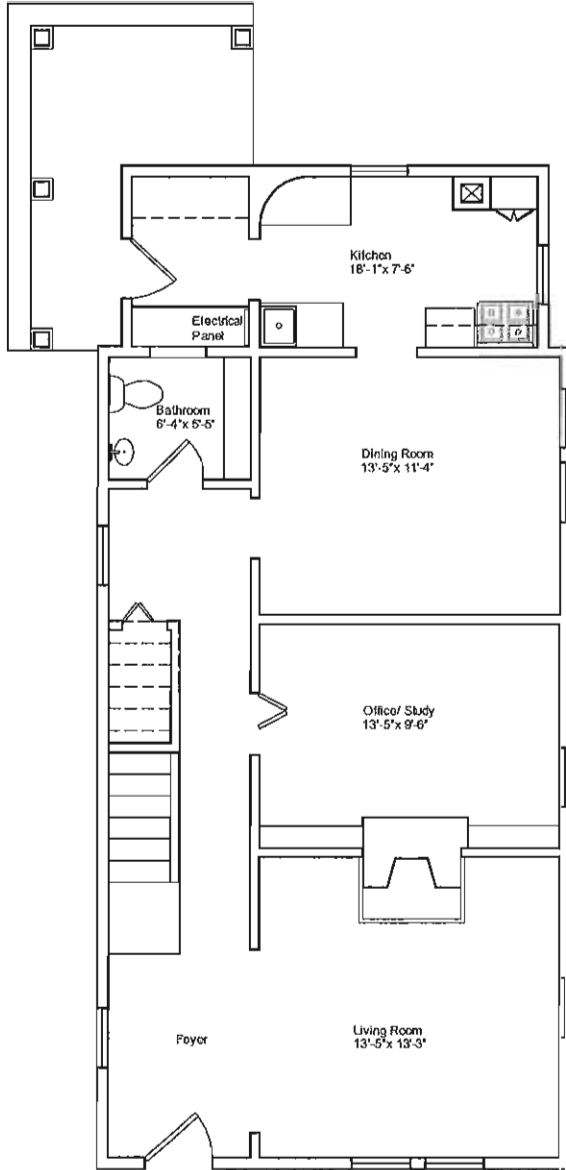

Ground Floor Plan - Existing

Scale - 1/8" = 1'-0"

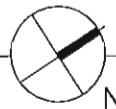

PELL ST studio

Architect
 Ashley Henkel Morris
 306 Poll Street
 Raleigh, NC 27604
 919.696.0970

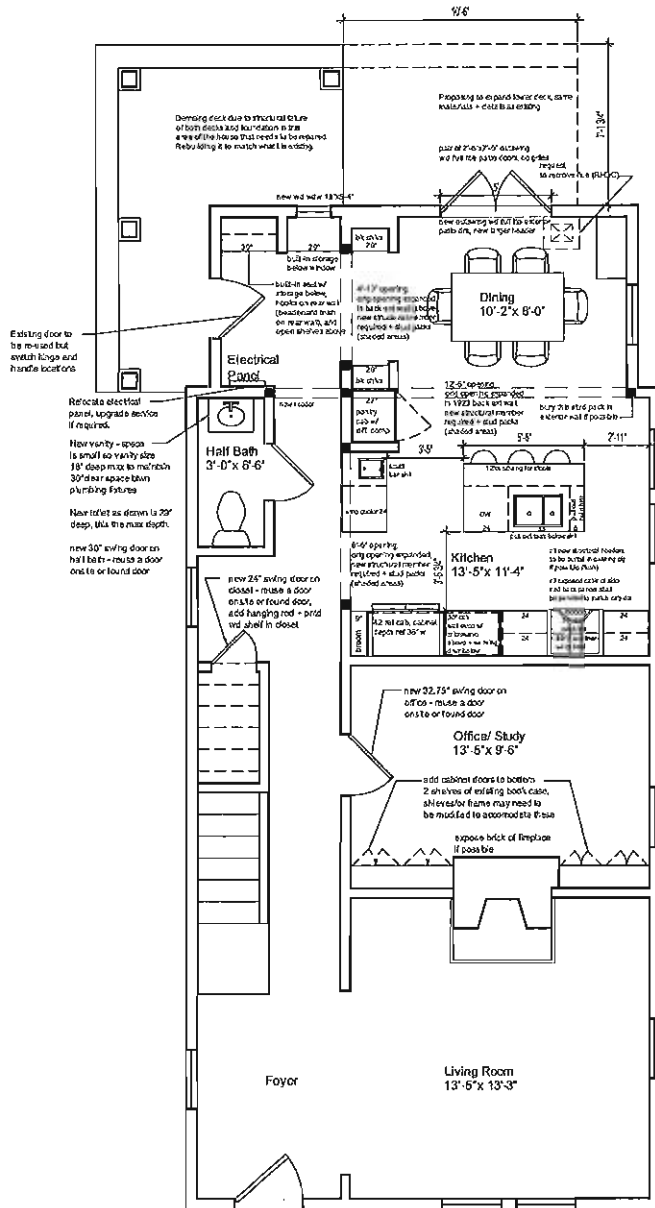

Ground Floor Plan - New

Scale - 1/8" = 1'-0"

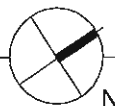

PELL ST studio

Architect
 Ashley Honkal Morris
 308 Pell Street
 Raleigh, NC 27604
 919.696.0970

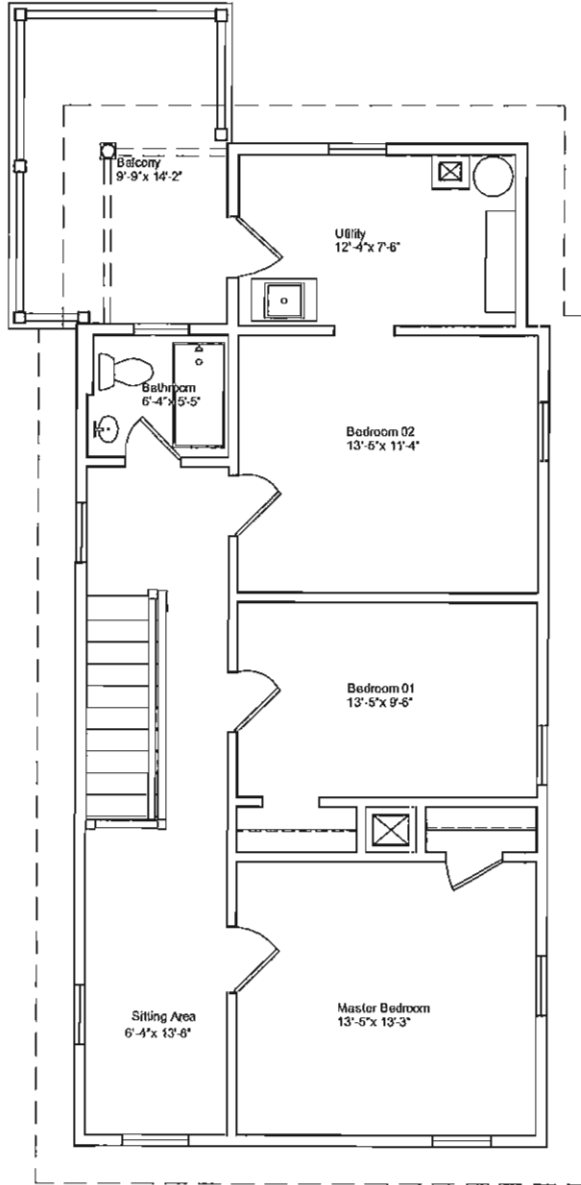

PELL ST studio

Architect
Ashley Henkel Morris
306 Pell Street
Raleigh, NC 27604
919.696.0970

Second Floor Plan - Existing

Scale - 1/8" = 1'-0"



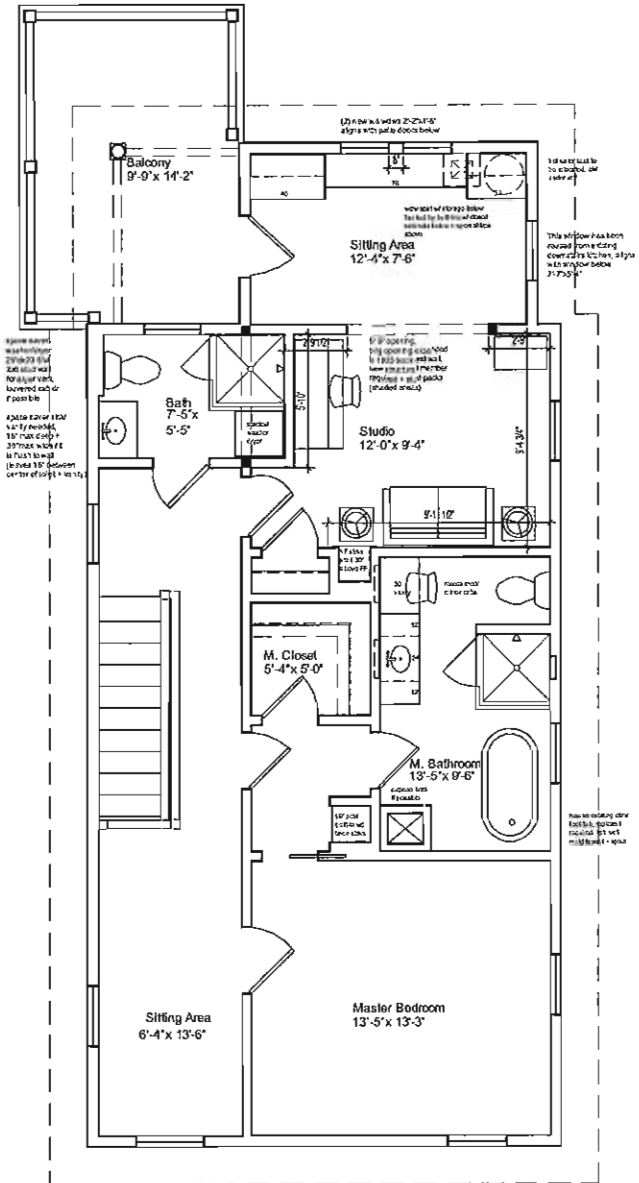

PELL ST studio

Architect
 Ashley Hankel Morris
 306 Pell Street
 Raleigh, NC 27604
 919.696.0970

Second Floor Plan - New

Scale - 1/8" = 1'-0"

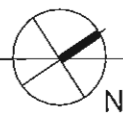

1-WIDE UNIT

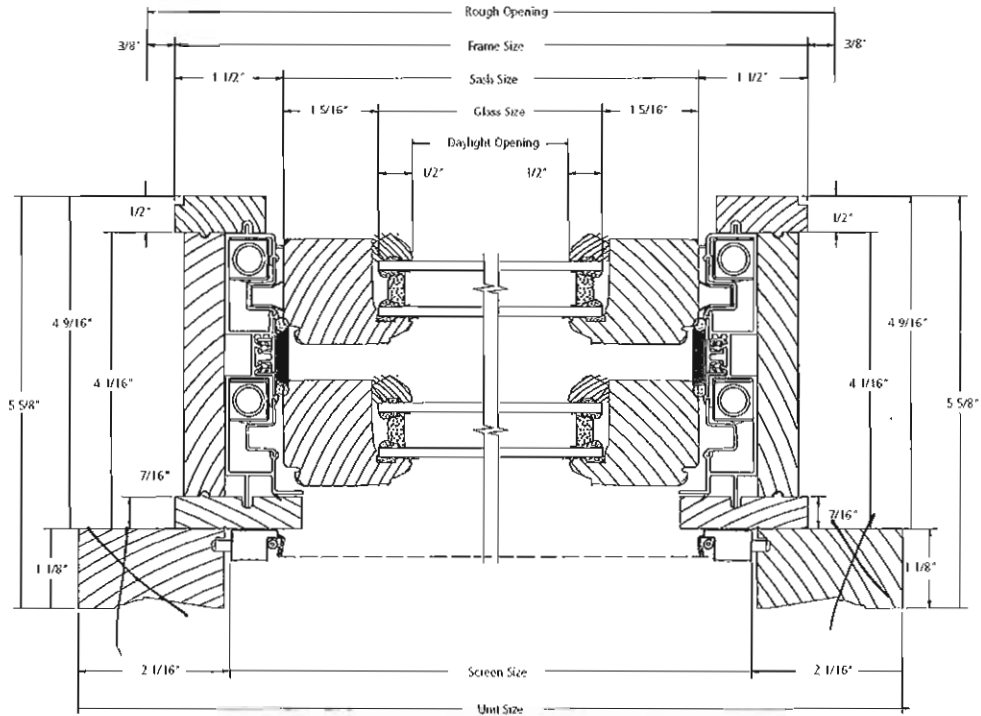

HORIZONTAL SECTION

See drawings for trim.
TGT

SCALE: 6" = 1'

1-WIDE UNIT
DP50

See dwgs
for trim.
TGT

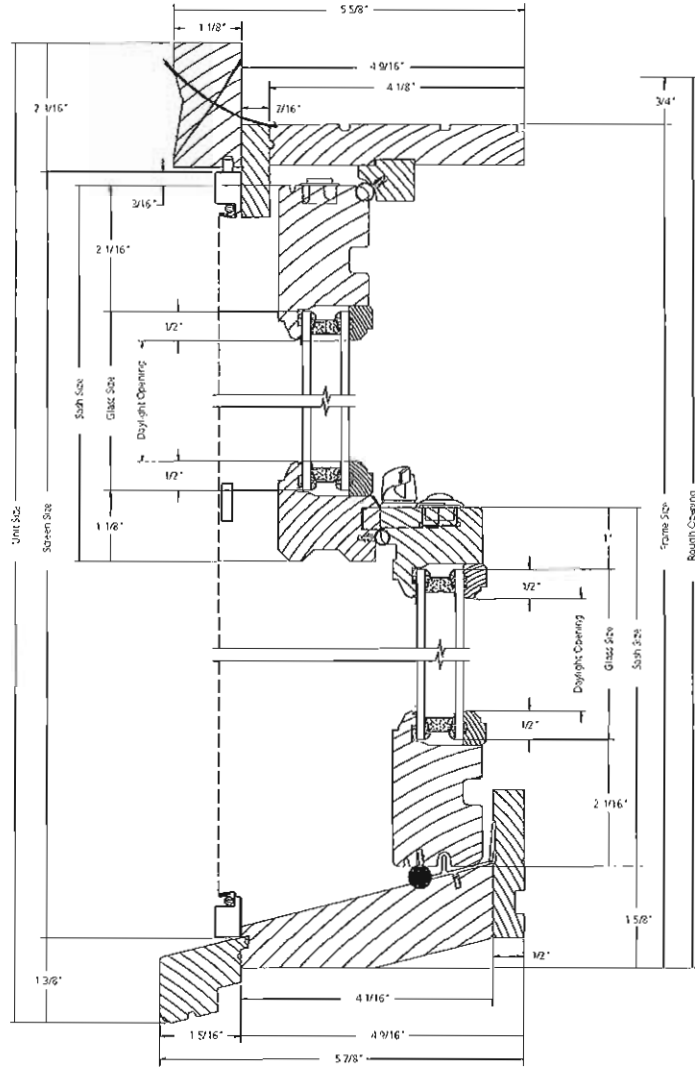

VERTICAL SECTION

SCALE: 6" = 1'

1-WIDE UNITS

M.O. BRICKMOLD
M.O. ADAMS/PLAT CASING
ROUGH OPENING
FRAME SIZE
DAYLIGHT OPENING

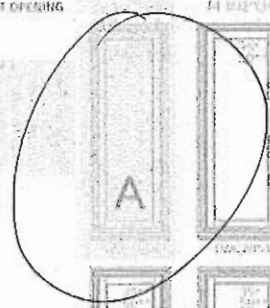

48 INCH HEIGHT
36 INCH WIDTH
36 INCH HEIGHT
36 INCH WIDTH

48 INCH HEIGHT
36 INCH WIDTH
36 INCH HEIGHT
36 INCH WIDTH

48 INCH HEIGHT
36 INCH WIDTH
36 INCH HEIGHT
36 INCH WIDTH

48 INCH HEIGHT
36 INCH WIDTH
36 INCH HEIGHT
36 INCH WIDTH

27 1/2" (700)	27 1/2" (700)	31 1/2" (800)	31 1/2" (800)	34 1/2" (880)	45 1/2" (1150)	45 1/2" (1150)
36 1/2" (925)	36 1/2" (925)	36 1/2" (925)	36 1/2" (925)	36 1/2" (925)	36 1/2" (925)	36 1/2" (925)
30 1/2" (775)	30 1/2" (775)	30 1/2" (775)	30 1/2" (775)	30 1/2" (775)	30 1/2" (775)	30 1/2" (775)
20" (508)	20" (508)	21" (533)	21" (533)	21" (533)	21" (533)	21" (533)
54 1/2" (1390)	54 1/2" (1390)	58 1/2" (1480)	58 1/2" (1480)	61 1/2" (1560)	71 1/2" (1820)	71 1/2" (1820)
EWC-2051	EWC-2051	EWC-2051	EWC-2051	EWC-2051	EWC-2051	EWC-2051
EWC-2052	EWC-2052	EWC-2052	EWC-2052	EWC-2052	EWC-2052	EWC-2052
EWC-2053	EWC-2053	EWC-2053	EWC-2053	EWC-2053	EWC-2053	EWC-2053
EWC-2054	EWC-2054	EWC-2054	EWC-2054	EWC-2054	EWC-2054	EWC-2054
EWC-2055	EWC-2055	EWC-2055	EWC-2055	EWC-2055	EWC-2055	EWC-2055
EWC-2056	EWC-2056	EWC-2056	EWC-2056	EWC-2056	EWC-2056	EWC-2056
EWC-2057	EWC-2057	EWC-2057	EWC-2057	EWC-2057	EWC-2057	EWC-2057
EWC-2058	EWC-2058	EWC-2058	EWC-2058	EWC-2058	EWC-2058	EWC-2058
EWC-2059	EWC-2059	EWC-2059	EWC-2059	EWC-2059	EWC-2059	EWC-2059
EWC-2060	EWC-2060	EWC-2060	EWC-2060	EWC-2060	EWC-2060	EWC-2060
EWC-2061	EWC-2061	EWC-2061	EWC-2061	EWC-2061	EWC-2061	EWC-2061
EWC-2062	EWC-2062	EWC-2062	EWC-2062	EWC-2062	EWC-2062	EWC-2062
EWC-2063	EWC-2063	EWC-2063	EWC-2063	EWC-2063	EWC-2063	EWC-2063
EWC-2064	EWC-2064	EWC-2064	EWC-2064	EWC-2064	EWC-2064	EWC-2064
EWC-2065	EWC-2065	EWC-2065	EWC-2065	EWC-2065	EWC-2065	EWC-2065
EWC-2066	EWC-2066	EWC-2066	EWC-2066	EWC-2066	EWC-2066	EWC-2066
EWC-2067	EWC-2067	EWC-2067	EWC-2067	EWC-2067	EWC-2067	EWC-2067
EWC-2068	EWC-2068	EWC-2068	EWC-2068	EWC-2068	EWC-2068	EWC-2068
EWC-2069	EWC-2069	EWC-2069	EWC-2069	EWC-2069	EWC-2069	EWC-2069
EWC-2070	EWC-2070	EWC-2070	EWC-2070	EWC-2070	EWC-2070	EWC-2070
EWC-2071	EWC-2071	EWC-2071	EWC-2071	EWC-2071	EWC-2071	EWC-2071
EWC-2072	EWC-2072	EWC-2072	EWC-2072	EWC-2072	EWC-2072	EWC-2072
EWC-2073	EWC-2073	EWC-2073	EWC-2073	EWC-2073	EWC-2073	EWC-2073
EWC-2074	EWC-2074	EWC-2074	EWC-2074	EWC-2074	EWC-2074	EWC-2074
EWC-2075	EWC-2075	EWC-2075	EWC-2075	EWC-2075	EWC-2075	EWC-2075
EWC-2076	EWC-2076	EWC-2076	EWC-2076	EWC-2076	EWC-2076	EWC-2076
EWC-2077	EWC-2077	EWC-2077	EWC-2077	EWC-2077	EWC-2077	EWC-2077
EWC-2078	EWC-2078	EWC-2078	EWC-2078	EWC-2078	EWC-2078	EWC-2078

See Material Finish Schedule
M.O. = Moulding Options
S.O. = Sash Options

E - MATERIALS BUNDLE REQUIREMENTS: SEE ETCO'S WEBSITE FOR COMPLETE INFORMATION. ALWAYS CHECK WITH YOUR SUPPLIER TO ENSURE ALL MATERIALS ARE AVAILABLE FOR YOUR PROJECT. CHECK WITH YOUR SUPPLIER TO ENSURE ALL MATERIALS ARE AVAILABLE FOR YOUR PROJECT.
F - INDICATES FINISH OPTIONS: SEE ETCO'S WEBSITE FOR COMPLETE INFORMATION.
M - INDICATES MOUNTING OPTIONS: SEE ETCO'S WEBSITE FOR COMPLETE INFORMATION.
R - INDICATES RAILING OPTIONS: SEE ETCO'S WEBSITE FOR COMPLETE INFORMATION.

Note: Dimensions shown are approximate. Subtract 1/2" (12.7 mm) from M.O. (Moulding) for Unit Size. Accuracy of dimensions shown include Mill Allowance. See Trim Options page for S.O. (Sash Options) specifications. For other Trim Options refer to the Unit Sizing, Rough Opening & Mounting Options page.

SCALE 1/4" = 1'

1-WIDE UNITS

M.O. HURRICANE
M.O. ADAMS/FLAT CASING
ROUGH OPENING
FRAME SIZE
PAINTED FINISH

24 1/2" x 61 1/2"
22 1/2" x 60 1/2"
23 1/8" x 61 1/2"
73 1/8" x 73 1/2"

26 1/2" x 63 1/2"
24 1/2" x 62 1/2"
25 1/8" x 63 1/2"
75 1/8" x 75 1/2"

32 1/2" x 69 1/2"
30 1/2" x 68 1/2"
31 1/8" x 69 1/2"
81 1/8" x 83 1/2"

34 1/2" x 71 1/2"
32 1/2" x 70 1/2"
33 1/8" x 71 1/2"
83 1/8" x 85 1/2"

36 1/2" x 73 1/2"
34 1/2" x 72 1/2"
35 1/8" x 73 1/2"
85 1/8" x 87 1/2"

40 1/2" x 79 1/2"
38 1/2" x 78 1/2"
39 1/8" x 79 1/2"
91 1/8" x 93 1/2"

43 1/2" x 81 1/2"
41 1/2" x 80 1/2"
42 1/8" x 81 1/2"
93 1/8" x 95 1/2"

63 1/2" x 115 1/2"
61 1/2" x 114 1/2"
62 1/8" x 115 1/2"
127 1/8" x 129 1/2"



71 1/2" x 123 1/2"
69 1/2" x 122 1/2"
70 1/8" x 123 1/2"
141 1/8" x 143 1/2"

75 1/2" x 127 1/2"
73 1/2" x 126 1/2"
74 1/8" x 127 1/2"
145 1/8" x 147 1/2"

81 1/2" x 133 1/2"
79 1/2" x 132 1/2"
80 1/8" x 133 1/2"
151 1/8" x 153 1/2"

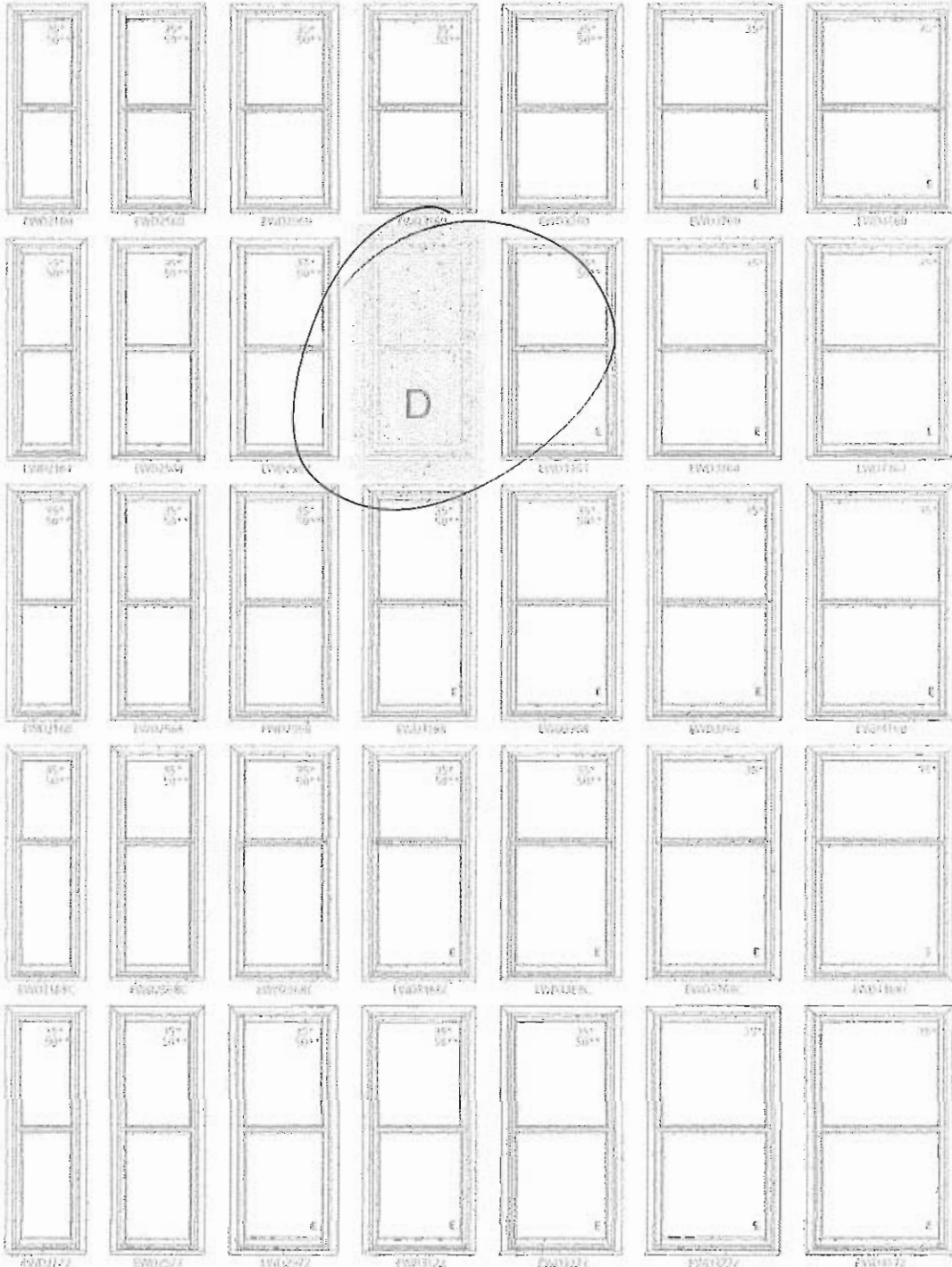

FINISHES SYMBOL LEGEND:
M.O. - HURRICANE
M.O. ADAMS/FLAT CASING
ROUGH OPENING
FRAME SIZE
PAINTED FINISH
W/O - WITHOUT
W/ - WITH
E - EXTERIOR
I - INTERIOR
R - RAIN
S - STORM
T - TYPICAL
U - UP
D - DOWN
L - LEFT
R - RIGHT
C - CENTER
E - EXTERIOR
I - INTERIOR
R - RAIN
S - STORM
T - TYPICAL
U - UP
D - DOWN
L - LEFT
R - RIGHT
C - CENTER

Note: Elevations shown DO NOT have exterior trim. Subtract 1/2" (12.7mm) M.O. Memory Opening for Unit Size. Memory Openings shown include Sill Molds, see Trim Options page for Sill Mold specifications. For other Trim Options refer to the Unit Sizing, Rough Opening & Memory Opening page.

SCALE 1/4" = 1'

1-WIDE UNITS

Model	24 1/2" (625)	27 1/2" (700)	32 1/2" (825)	34 1/2" (875)	36 1/2" (925)	40 1/2" (1025)	44 1/2" (1125)
M.O. BRICKMUD	24 1/2" (625)	27 1/2" (700)	32 1/2" (825)	34 1/2" (875)	36 1/2" (925)	40 1/2" (1025)	44 1/2" (1125)
M.O. ADAMS/FLAT CASING	24 1/2" (625)	27 1/2" (700)	32 1/2" (825)	34 1/2" (875)	36 1/2" (925)	40 1/2" (1025)	44 1/2" (1125)
ROUGH OPENING	24 1/2" (625)	27 1/2" (700)	32 1/2" (825)	34 1/2" (875)	36 1/2" (925)	40 1/2" (1025)	44 1/2" (1125)
FRAME SIZE	24 1/2" (625)	27 1/2" (700)	32 1/2" (825)	34 1/2" (875)	36 1/2" (925)	40 1/2" (1025)	44 1/2" (1125)
DAYLIGHT OPENING	14 1/2" (368)	17 1/2" (443)	22 1/2" (573)	24 1/2" (623)	26 1/2" (673)	30 1/2" (773)	34 1/2" (873)
36 1/2" (925)	39 1/2" (1000)	44 1/2" (1125)	49 1/2" (1250)	51 1/2" (1300)	53 1/2" (1350)	57 1/2" (1450)	61 1/2" (1550)
39 1/2" (1000)	42 1/2" (1075)	47 1/2" (1200)	49 1/2" (1250)	51 1/2" (1300)	53 1/2" (1350)	57 1/2" (1450)	61 1/2" (1550)
42 1/2" (1075)	45 1/2" (1150)	50 1/2" (1275)	52 1/2" (1325)	54 1/2" (1375)	58 1/2" (1475)	62 1/2" (1575)	66 1/2" (1675)
45 1/2" (1150)	48 1/2" (1225)	53 1/2" (1350)	55 1/2" (1400)	57 1/2" (1450)	61 1/2" (1550)	65 1/2" (1650)	69 1/2" (1750)
48 1/2" (1225)	51 1/2" (1300)	56 1/2" (1425)	58 1/2" (1475)	60 1/2" (1525)	64 1/2" (1625)	68 1/2" (1725)	72 1/2" (1825)
51 1/2" (1300)	54 1/2" (1375)	59 1/2" (1500)	61 1/2" (1550)	63 1/2" (1600)	67 1/2" (1700)	71 1/2" (1800)	75 1/2" (1900)
54 1/2" (1375)	57 1/2" (1450)	62 1/2" (1575)	64 1/2" (1625)	66 1/2" (1675)	70 1/2" (1775)	74 1/2" (1875)	78 1/2" (1975)
57 1/2" (1450)	60 1/2" (1525)	65 1/2" (1650)	67 1/2" (1700)	69 1/2" (1750)	73 1/2" (1850)	77 1/2" (1950)	81 1/2" (2050)
60 1/2" (1525)	63 1/2" (1600)	68 1/2" (1725)	70 1/2" (1775)	72 1/2" (1825)	76 1/2" (1925)	80 1/2" (2025)	84 1/2" (2125)
63 1/2" (1600)	66 1/2" (1675)	71 1/2" (1800)	73 1/2" (1850)	75 1/2" (1900)	79 1/2" (2000)	83 1/2" (2100)	87 1/2" (2200)
66 1/2" (1675)	69 1/2" (1750)	74 1/2" (1875)	76 1/2" (1925)	78 1/2" (1975)	82 1/2" (2075)	86 1/2" (2175)	90 1/2" (2275)
69 1/2" (1750)	72 1/2" (1825)	77 1/2" (1950)	79 1/2" (2000)	81 1/2" (2050)	85 1/2" (2150)	89 1/2" (2250)	93 1/2" (2350)
72 1/2" (1825)	75 1/2" (1900)	80 1/2" (2025)	82 1/2" (2075)	84 1/2" (2125)	88 1/2" (2225)	92 1/2" (2325)	96 1/2" (2425)
75 1/2" (1900)	78 1/2" (1975)	83 1/2" (2100)	85 1/2" (2150)	87 1/2" (2200)	91 1/2" (2300)	95 1/2" (2400)	99 1/2" (2500)
78 1/2" (1975)	81 1/2" (2050)	86 1/2" (2175)	88 1/2" (2225)	90 1/2" (2275)	94 1/2" (2375)	98 1/2" (2475)	102 1/2" (2575)
81 1/2" (2050)	84 1/2" (2125)	89 1/2" (2250)	91 1/2" (2300)	93 1/2" (2350)	97 1/2" (2450)	101 1/2" (2550)	105 1/2" (2650)
84 1/2" (2125)	87 1/2" (2200)	92 1/2" (2325)	94 1/2" (2375)	96 1/2" (2425)	100 1/2" (2525)	104 1/2" (2625)	108 1/2" (2725)
87 1/2" (2200)	90 1/2" (2275)	95 1/2" (2400)	97 1/2" (2450)	99 1/2" (2500)	103 1/2" (2600)	107 1/2" (2700)	111 1/2" (2800)
90 1/2" (2275)	93 1/2" (2350)	98 1/2" (2475)	100 1/2" (2525)	102 1/2" (2575)	106 1/2" (2675)	110 1/2" (2775)	114 1/2" (2875)
93 1/2" (2350)	96 1/2" (2425)	101 1/2" (2550)	103 1/2" (2600)	105 1/2" (2650)	109 1/2" (2750)	113 1/2" (2850)	117 1/2" (2950)
96 1/2" (2425)	99 1/2" (2500)	104 1/2" (2625)	106 1/2" (2675)	108 1/2" (2725)	112 1/2" (2825)	116 1/2" (2925)	120 1/2" (3025)
99 1/2" (2500)	102 1/2" (2575)	107 1/2" (2700)	109 1/2" (2750)	111 1/2" (2800)	115 1/2" (2900)	119 1/2" (3000)	123 1/2" (3100)
102 1/2" (2575)	105 1/2" (2650)	110 1/2" (2775)	112 1/2" (2825)	114 1/2" (2875)	118 1/2" (2975)	122 1/2" (3075)	126 1/2" (3175)
105 1/2" (2650)	108 1/2" (2725)	113 1/2" (2850)	115 1/2" (2900)	117 1/2" (2950)	121 1/2" (3050)	125 1/2" (3150)	129 1/2" (3250)
108 1/2" (2725)	111 1/2" (2800)	116 1/2" (2925)	118 1/2" (2975)	120 1/2" (3025)	124 1/2" (3125)	128 1/2" (3225)	132 1/2" (3325)
111 1/2" (2800)	114 1/2" (2875)	119 1/2" (3000)	121 1/2" (3050)	123 1/2" (3100)	127 1/2" (3200)	131 1/2" (3300)	135 1/2" (3400)
114 1/2" (2875)	117 1/2" (2950)	122 1/2" (3075)	124 1/2" (3125)	126 1/2" (3175)	130 1/2" (3275)	134 1/2" (3375)	138 1/2" (3475)
117 1/2" (2950)	120 1/2" (3025)	125 1/2" (3150)	127 1/2" (3200)	129 1/2" (3250)	133 1/2" (3350)	137 1/2" (3450)	141 1/2" (3550)
120 1/2" (3025)	123 1/2" (3100)	128 1/2" (3225)	130 1/2" (3275)	132 1/2" (3325)	136 1/2" (3425)	140 1/2" (3525)	144 1/2" (3625)
123 1/2" (3100)	126 1/2" (3175)	131 1/2" (3300)	133 1/2" (3350)	135 1/2" (3400)	139 1/2" (3500)	143 1/2" (3600)	147 1/2" (3700)
126 1/2" (3175)	129 1/2" (3250)	134 1/2" (3375)	136 1/2" (3425)	138 1/2" (3475)	142 1/2" (3575)	146 1/2" (3675)	150 1/2" (3775)
129 1/2" (3250)	132 1/2" (3325)	137 1/2" (3450)	139 1/2" (3500)	141 1/2" (3550)	145 1/2" (3650)	149 1/2" (3750)	153 1/2" (3850)
132 1/2" (3325)	135 1/2" (3400)	140 1/2" (3525)	142 1/2" (3575)	144 1/2" (3625)	148 1/2" (3725)	152 1/2" (3825)	156 1/2" (3925)
135 1/2" (3400)	138 1/2" (3475)	143 1/2" (3600)	145 1/2" (3650)	147 1/2" (3700)	151 1/2" (3800)	155 1/2" (3900)	159 1/2" (4000)
138 1/2" (3475)	141 1/2" (3550)	146 1/2" (3675)	148 1/2" (3725)	150 1/2" (3775)	154 1/2" (3875)	158 1/2" (3975)	162 1/2" (4075)
141 1/2" (3550)	144 1/2" (3625)	149 1/2" (3750)	151 1/2" (3800)	153 1/2" (3850)	157 1/2" (3950)	161 1/2" (4050)	165 1/2" (4150)
144 1/2" (3625)	147 1/2" (3700)	152 1/2" (3825)	154 1/2" (3875)	156 1/2" (3925)	160 1/2" (4025)	164 1/2" (4125)	168 1/2" (4225)
147 1/2" (3700)	150 1/2" (3775)	155 1/2" (3900)	157 1/2" (3950)	159 1/2" (4000)	163 1/2" (4100)	167 1/2" (4200)	171 1/2" (4300)
150 1/2" (3775)	153 1/2" (3850)	158 1/2" (4000)	160 1/2" (4050)	162 1/2" (4100)	166 1/2" (4200)	170 1/2" (4300)	174 1/2" (4400)
153 1/2" (3850)	156 1/2" (3925)	161 1/2" (4100)	163 1/2" (4150)	165 1/2" (4200)	169 1/2" (4300)	173 1/2" (4400)	177 1/2" (4500)
156 1/2" (3925)	159 1/2" (4000)	164 1/2" (4150)	166 1/2" (4200)	168 1/2" (4250)	172 1/2" (4350)	176 1/2" (4450)	180 1/2" (4550)
159 1/2" (4000)	162 1/2" (4075)	167 1/2" (4250)	169 1/2" (4300)	171 1/2" (4350)	175 1/2" (4450)	179 1/2" (4550)	183 1/2" (4650)
162 1/2" (4075)	165 1/2" (4150)	170 1/2" (4350)	172 1/2" (4400)	174 1/2" (4450)	178 1/2" (4550)	182 1/2" (4650)	186 1/2" (4750)
165 1/2" (4150)	168 1/2" (4225)	173 1/2" (4450)	175 1/2" (4500)	177 1/2" (4550)	181 1/2" (4650)	185 1/2" (4750)	189 1/2" (4850)
168 1/2" (4225)	171 1/2" (4300)	176 1/2" (4550)	178 1/2" (4600)	180 1/2" (4650)	184 1/2" (4750)	188 1/2" (4850)	192 1/2" (4950)
171 1/2" (4300)	174 1/2" (4375)	179 1/2" (4650)	181 1/2" (4700)	183 1/2" (4750)	187 1/2" (4850)	191 1/2" (4950)	195 1/2" (5050)
174 1/2" (4375)	177 1/2" (4450)	182 1/2" (4750)	184 1/2" (4800)	186 1/2" (4850)	190 1/2" (4950)	194 1/2" (5050)	198 1/2" (5150)
177 1/2" (4450)	180 1/2" (4525)	185 1/2" (4850)	187 1/2" (4900)	189 1/2" (4950)	193 1/2" (5050)	197 1/2" (5150)	201 1/2" (5250)
180 1/2" (4525)	183 1/2" (4600)	188 1/2" (4950)	190 1/2" (5000)	192 1/2" (5050)	196 1/2" (5150)	200 1/2" (5250)	204 1/2" (5350)
183 1/2" (4600)	186 1/2" (4675)	191 1/2" (5050)	193 1/2" (5100)	195 1/2" (5150)	199 1/2" (5250)	203 1/2" (5350)	207 1/2" (5450)
186 1/2" (4675)	189 1/2" (4750)	194 1/2" (5150)	196 1/2" (5200)	198 1/2" (5250)	202 1/2" (5350)	206 1/2" (5450)	210 1/2" (5550)
189 1/2" (4750)	192 1/2" (4825)	197 1/2" (5250)	199 1/2" (5300)	201 1/2" (5350)	205 1/2" (5450)	209 1/2" (5550)	213 1/2" (5650)
192 1/2" (4825)	195 1/2" (4900)	200 1/2" (5350)	202 1/2" (5400)	204 1/2" (5450)	208 1/2" (5550)	212 1/2" (5650)	216 1/2" (5750)
195 1/2" (4900)	198 1/2" (4975)	203 1/2" (5450)	205 1/2" (5500)	207 1/2" (5550)	211 1/2" (5650)	215 1/2" (5750)	219 1/2" (5850)
198 1/2" (4975)	201 1/2" (5050)	206 1/2" (5550)	208 1/2" (5600)	210 1/2" (5650)	214 1/2" (5750)	218 1/2" (5850)	222 1/2" (5950)
201 1/2" (5050)	204 1/2" (5125)	209 1/2" (5650)	211 1/2" (5700)	213 1/2" (5750)	217 1/2" (5850)	221 1/2" (5950)	225 1/2" (6050)
204 1/2" (5125)	207 1/2" (5200)	212 1/2" (5750)	214 1/2" (5800)	216 1/2" (5850)	220 1/2" (5950)	224 1/2" (6050)	228 1/2" (6150)
207 1/2" (5200)	210 1/2" (5275)	215 1/2" (5850)	217 1/2" (5900)	219 1/2" (5950)	223 1/2" (6050)	227 1/2" (6150)	231 1/2" (6250)
210 1/2" (5275)	213 1/2" (5350)	218 1/2" (5950)	220 1/2" (6000)	222 1/2" (6050)	226 1/2" (6150)	230 1/2" (6250)	234 1/2" (6350)
213 1/2" (5350)	216 1/2" (5425)	221 1/2" (6050)	223 1/2" (6100)	225 1/2" (6150)	229 1/2" (6250)	233 1/2" (6350)	237 1/2" (6450)
216 1/2" (5425)	219 1/2" (5500)	224 1/2" (6150)	226 1/2" (6200)	228 1/2" (6250)	232 1/2" (6350)	236 1/2" (6450)	240 1/2" (6550)
219 1/2" (5500)	222 1/2" (5575)	227 1/2" (6250)	229 1/2" (6300)	231 1/2" (6350)	235 1/2" (6450)	239 1/2" (6550)	243 1/2" (6650)
222 1/2" (5575)	225 1/2" (5650)	230 1/2" (6350)	232 1/2" (6400)	234 1/2" (6450)	238 1/2" (6550)	242 1/2" (6650)	246 1/2" (6750)
225 1/2" (5650)	228 1/2" (5725)	233 1/2" (6450)	235 1/2" (6500)	237 1/2" (6550)	241 1/2" (6650)	245 1/2" (6750)	249 1/2" (6850)
228 1/2" (5725)	231 1/2" (5800)	236 1/2" (6550)	238 1/2" (6600)	240 1/2" (6650)	244 1/2" (6750)	248 1/2" (6850)	252 1/2" (6950)
231 1/2" (5800)	234 1/2" (5875)	239 1/2" (6650)	241 1/2" (6700)	243 1/2" (6750)	247 1/2" (6850)	251 1/2" (6950)	255 1/2" (7050)
234 1/2" (5875)	237 1/2" (5950)	242 1/2" (6750)	244 1/2" (6800)	246 1/2" (6850)	250 1/2" (6950)	254 1/2" (7050)	258 1/2" (7150)
237 1/2" (5950)	240 1/2" (6025)	245 1/2" (6850)	247 1/2" (6900)	249 1/2" (6950)	253 1/2" (7050)	257 1/2" (7150)	261 1/2" (7250)
240 1/2" (6025)	243 1/2" (6100)	248 1/2" (6950)	250 1/2" (7000)	252 1/2" (7050)	256 1/2" (7150)	260 1/2" (7250)	264 1/2" (7350)
243 1/2" (6100)	246 1/2" (6175)	251 1/2" (7150)	253 1/2" (7200)	255 1/2" (7250)	259 1/2" (7350)	263 1/2" (7450)	267 1/2" (7550)
246 1/2" (6175)	249 1/2" (6250)	254 1/2" (7250)	256 1/2" (7300)	258 1/2" (7350)	262 1/2" (7450)	266 1/2" (7550)	270 1/2" (7650)
249 1/2" (6250)	252 1/2" (6325)	257 1/2" (7350)	259 1/2" (7400)	261 1/2" (7450)	265 1/2" (7550)	269 1/2" (7650)	273 1/2" (7750)
252 1/2" (6325)	255 1/2" (6400)	260 1/2"					

DIVIDED LITE OPTIONS

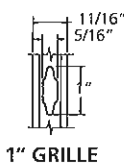
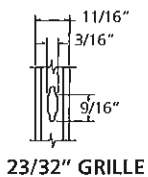
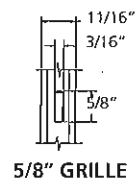
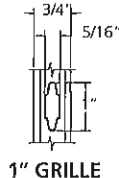
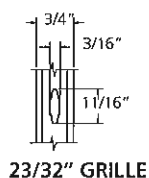
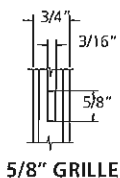
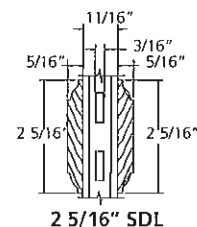
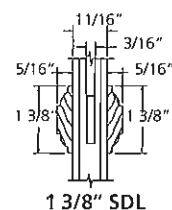
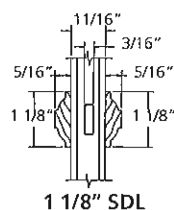
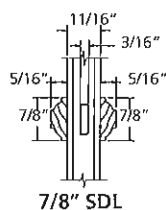
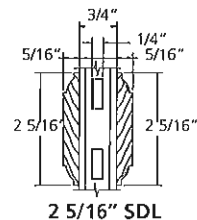
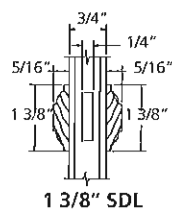
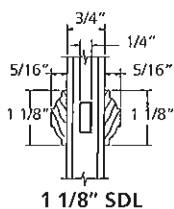
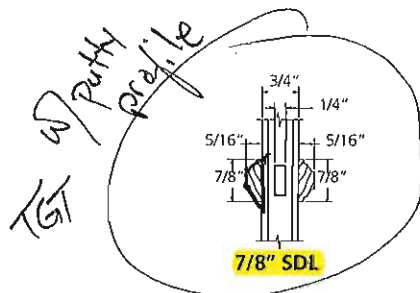

GRILLES MEETING
NFRC 3mm RULE

GRILLE PROFILES:

3/16" x 5/8"	ALLMETAL 1021101018XX140
3/16" x 1"	ALLMETAL 1020101018XX164
1/4" x 5/8"	ALLMETAL 1020102018XX140
1/4" x 1"	ALLMETAL 1020102018XX164
5.5mm x 18mm CONTOUR	ALLMETAL 1020301010XX255
8mm x 25mm CONTOUR	ALLMETAL 1020301018XX380

Note: All glass and airspace dimensions per current cardinal glass specs. Lites with shapes, angles or radii outside the Lisec Bender capabilities for stainless steel warm edge spacer will have aluminum box spacer with the same airspace dimension shown here.

SCALE 3" = 1'

PRODUCT SPECIFICATIONS

EXTERIOR FINISH

All exterior surfaces are covered with a factory-applied latex primer.

AURALAST® WOOD

AuraLast® wood is fundamentally different from wood resulting from traditional millwork preservation processes in that it uses a proprietary vacuum/pressure process to provide protection throughout the wood parts used to make windows and doors. AuraLast® wood is distinguished from wood using the current preservation methods by its unique ability to achieve greater penetration of the active ingredients into the wood parts, with a penetration of the treatment being a minimum of 92%.

INTERIOR FINISH

All interior surfaces are unfinished clear pine ready for on site finishing. Primed and pre-finished interiors are available in paint: Pure White, Extra White, Natural Choice, Moderate White; in stain: Wheat, Cherry, Cordovan; and Clear Lacquer.

FRAME

Frame is assembled from select kiln dried pine using AuraLast® wood on all exterior parts. Frame corner joints are tightly secured with metal fasteners and adhesive. Frame thickness is 1 1/16" (17.5mm) at head, side jamb and sill. Basic jamb width is 4-9/16" (116mm) and may be extended for different wall depths. Finished frame has exterior casing, sill nosing, weather-stripping, hardware, and interior stops applied.

SASH

Sash is 1-7/16" (36.5mm) thick select kiln-dried pine using AuraLast® wood. Stiles and rails are mortise and tenoned, machine clamped for squareness and secured with metal fasteners. The glass is mounted into the sash using a silicone-glazing compound on the exterior and acrylic sealant on the interior, then secured with interior applied profiled wood stops. Sash operate in a non-compression ivory colored jamb liner that allows both top and bottom sash to tilt inside for easy cleaning and removal without the use of tools. No finger plow sash available on venting units.

GLAZING

3/4" (19mm) thick sealed insulating glass is constructed from two panes of glass, utilizing a continuous roll formed stainless steel spacer with dual seal sealant. The glass is mounted into the sash using a silicone-glazing compound and secured with interior applied profiled wood stops. All insulating glass units comply with the performance requirements of IGCC in accordance with either ASTM E774 or E2190.

GLAZING OPTIONS

3/4" insulating glass available in Low-E with Argon, Low-E, Low-E 366, Clear, Neat Glass, reflective, tinted, or obscure, tempered or other specialty glass as specified. Preserve® film is a 0.003" thick polyethylene film with a low tack acrylic adhesive applied to the glass for protection during shipping and installation. 4,000 foot elevations and higher require a capillary tube to equalize environmental stress (otherwise known as High Altitude glazing). High Altitude glazing does not allow the use of Argon as listed under glazing options.

WEATHER-STRIPPING

Engineered system combines PVC ivory jamb liner with dual bulb weather-stripping at head. Checkrail features thermoplastic rubber bulb and recessed cam action sash lock for secure closure. Rigid vinyl water stops at sill provide additional restraint against weather.

HARDWARE

Sash operate by means of a dual block and tackle balance system with nylon roller pulleys and high-tension coil springs. Balance system gauged to sash weight and uses pre-stretched dacron cords attached to clutch mechanisms to insure smooth, operation and compliance with operating force requirements. Jamb liners are Ivory (White is optional). Recessed cam action sash lock is available in White, Chestnut Bronze, Desert Sand or optional Bright Brass, Antique Brass, Polished Brass, Brushed Chrome or Imitation Oil Rubbed Bronze. 28" glass width and larger units have two sash locks. Optional Lexan sash lift available for no finger plow sash.

EXTERIOR INSECT SCREENS

Charcoal fiberglass screen cloth (18x16 mesh) set in painted roll formed aluminum frame with color to match cladding - choice of Brilliant White, Chestnut Bronze, Desert Sand, French Vanilla, Hartford Green, Mesa Red, Black, Arctic Silver or Dark Chocolate, installed in channel on frame extrusion and held in place with spring loaded plungers at the top and sides of screen. Aluminum mesh and Phantom screen also available. Insect screens are intended to allow air and light in and to keep insects out. They are not intended to keep anyone or anything from falling through an open window. For safety screens or other security devices contact your local building supply retailer.

GRILLES

SDL (Simulated Divided Lites) - wood muntins permanently applied to the exterior of the insulating glass unit (not available on textured glass) in 7/8" (22mm), 1-1/8" (28.5mm), or 1-3/8" (34.9mm) widths. SDL is standard with a light bronze internal shadow bar to give a true divided lite appearance. As an option, SDL may be ordered with a silver shadow bar. Clear wood interior muntin bars match the exterior muntin width and are permanently bonded to the interior of the glass. Also available is a 2-5/16" (59mm) SDL bar, which simulates a double-hung checkrail.

Full Surround Wood Grilles - Rectangular unfinished clear pine wood grilles in 7/8" (22mm) are available in patterns selected by the owner.

GBG (Grilles between the Glass) - 5/8" (15.9mm) flat and 23/32" or 1" contour mounted between the glass panes suspended within the air cavity.

EXTERIOR TRIM

1-3/32" (27.8mm) x 2" (50.8mm) brickmould with 1-1/16" (27mm) x 1-3/4" (44.5mm) nosing is standard. Flat casing is available as 1-3/32" (27.8mm) x 2" (50.8mm), 1-3/32" (27.8mm) x 3-1/2" (89mm), 1-3/32" (27.8mm) x 4-1/2" (114.3mm), and 1-3/32" (27.8mm) x 5-1/2" (139.7mm). The following profiled casings are available: RB-3 and Adams as 1-1/16" x 3-1/2" (89mm), and Williamsburg 1-3/16" x 3-1/4". Historical wood sill nosing 1-3/4" (44.5mm) and 2-13/16" (71.4mm) is also available.

can be non-wood if putty profile

Continued on next page

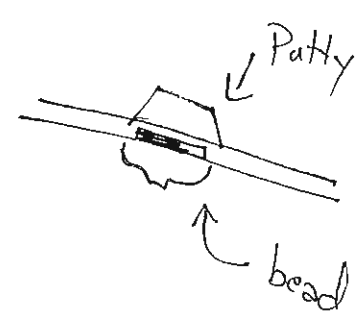

PRODUCT SPECIFICATIONS

EXTENSION JAMBS

Extension jambs are factory applied to the interior on all four sides of the frame and are 4/4 standard thick pine to accommodate wall depths up to 9-5/16" with one piece, and up to 12" with two pieces. 9/16" (14.2mm) option also available.

INSTALLATION

Installation per JELD-WEN Installation Method for Wood Windows JII003 or JII012. See www.jeld-wen.com/resources for instructions.

PERFORMANCE

NFRC Certified - (Rated and labeled in accordance with NFRC)

WDMA Hallmark Certified -
In accordance with **AAMA/NWWDA/101/I.S.2-97**

QUICK SPEC GUIDE

SPECIFICATION	STANDARD FEATURES	OPTIONAL FEATURES <i>Some options may require additional lead times. Consult your JELD-WEN Sales Representative.</i>
FRAME	<ul style="list-style-type: none"> Fingerjoint Wood 	
EXTERIOR FINISH	<ul style="list-style-type: none"> Primed 	<ul style="list-style-type: none"> Natural
EXTERIOR TRIM	<ul style="list-style-type: none"> 1-3/32" Brickmould Drip Cap 	<ul style="list-style-type: none"> Flat Casing: 1-3/32" x 2", 3-1/2", 4-1/2", and 5-1/2" Williamsburg Casing: 1-3/16" x 3-1/4" RB-3 Casing: 1-1/16" x 3-1/2" Adams Casing: 1-1/16" x 3-1/2" 1X4 Backband Casing: 1-7/32" x 4-1/2" 2" Historical Nosing No Brickmould Option
INTERIOR FINISH	<ul style="list-style-type: none"> Natural 	<ul style="list-style-type: none"> Priming Available <p>Pre-finished Interior Options are:</p> <ul style="list-style-type: none"> Paint - Pure White, Extra White, Natural Choice, Moderate White Stain - Wheat, Fruitwood, Cherry, Cordovan Clear Lacquer
SIZE	<ul style="list-style-type: none"> Width: <ul style="list-style-type: none"> Venting Double-Hung: 21-3/8, 25-3/8, 29-3/8, 31-3/8, 33-3/8, 37-3/8, 41-3/8, 45-3/8 Picture Double-Hung: 21-3/8, 25-3/8, 29-3/8, 31-3/8, 33-3/8, 37-3/8, 41-3/8, 45-3/8, 49-3/8, 53-3/8, 61-3/8, 69-3/8, 77-3/8 Height: <ul style="list-style-type: none"> Venting Double-Hung: 32, 36, 40, 44, 48, 52, 56, 60, 64, 68, 72, 76, 80, 88, 92 Picture Double-Hung: 15, 18, 24, 32, 36, 40, 44, 48, 52, 56, 60, 64, 68, 72, 76, 80, 88, 92 For RO, add 3/4" 	<ul style="list-style-type: none"> Width: <ul style="list-style-type: none"> Venting Double-Hung: <ul style="list-style-type: none"> Minimum: 16" Maximum: 45-3/8" Picture Double-Hung: <ul style="list-style-type: none"> Minimum: 16" Maximum: 77-3/8" Fixed Units over 49-3/8" wide can be up to 80" high Fixed Units up to 49-3/8" wide can be up to 92" high Height: <ul style="list-style-type: none"> Venting Double-Hung: <ul style="list-style-type: none"> Minimum: 28" Maximum: 92" * * glass can't exceed 42" high Picture Double-Hung: <ul style="list-style-type: none"> Minimum: 15" Maximum: 92" Fixed Units over 49-3/8" wide can be up to 80" high Fixed Units up to 49-3/8" wide can be up to 92" high For RO, add 3/4"
GLAZING	<ul style="list-style-type: none"> Low-E Insulating Glass Preserve® Protective Film 	<ul style="list-style-type: none"> Clear Obscure Bronze Low-E 366 High Altitude Neat Glass Reflective Tempered

Continued on next page

QUICK SPEC GUIDE

SPECIFICATION	STANDARD FEATURES	OPTIONAL FEATURES <i>Some options may require additional lead times. Consult your JELD-WEN Sales Representative.</i>
GRILLES	<p style="text-align: center;"><i>Petty Profile</i></p>	<ul style="list-style-type: none"> • 5/8" Flat, 23/32" or 1" Contour GBG • 7/8" Full Surround Wood Grilles • SDI Bead Profile: • 7/8", 1-1/8", 1-3/8", 2-5/16" with Light Bronze Shadow Bar • 7/8", 1-1/8", 1-3/8", 2-5/16" with Silver Shadow Bar
HARDWARE	<ul style="list-style-type: none"> • Balance: Dual Block and Tackle • Cam Locks • Ivory Jamb Liners (standard) 	<ul style="list-style-type: none"> • White
HARDWARE COLOR	<ul style="list-style-type: none"> • White • Desert Sand • Chestnut Bronze 	<ul style="list-style-type: none"> • Antique Brass • Polished Brass • Brushed Chrome • Imitation Oil Rubbed Bronze
JAMB	<ul style="list-style-type: none"> • 4-9/16" 	<ul style="list-style-type: none"> • Minimum: 4-9/16" • Maximum: 9-5/16" (one piece) • Maximum: 12" (two piece)
SCREENS	<ul style="list-style-type: none"> • Fiberglass 	<ul style="list-style-type: none"> • Aluminum Mesh available • Phantom Screen - some size limitations apply
SCREEN FRAME COLOR	<ul style="list-style-type: none"> <li style="width: 50%;">• Brilliant White <li style="width: 50%;">• Hartford Green <li style="width: 50%;">• Chestnut Bronze <li style="width: 50%;">• Black <li style="width: 50%;">• Desert Sand <li style="width: 50%;">• Arctic Silver <li style="width: 50%;">• French Vanilla <li style="width: 50%;">• Dark Chocolate <li style="width: 50%;">• Mesa Red 	

FRENCH IN-SWING

*See drawings
for trim.
JGT*

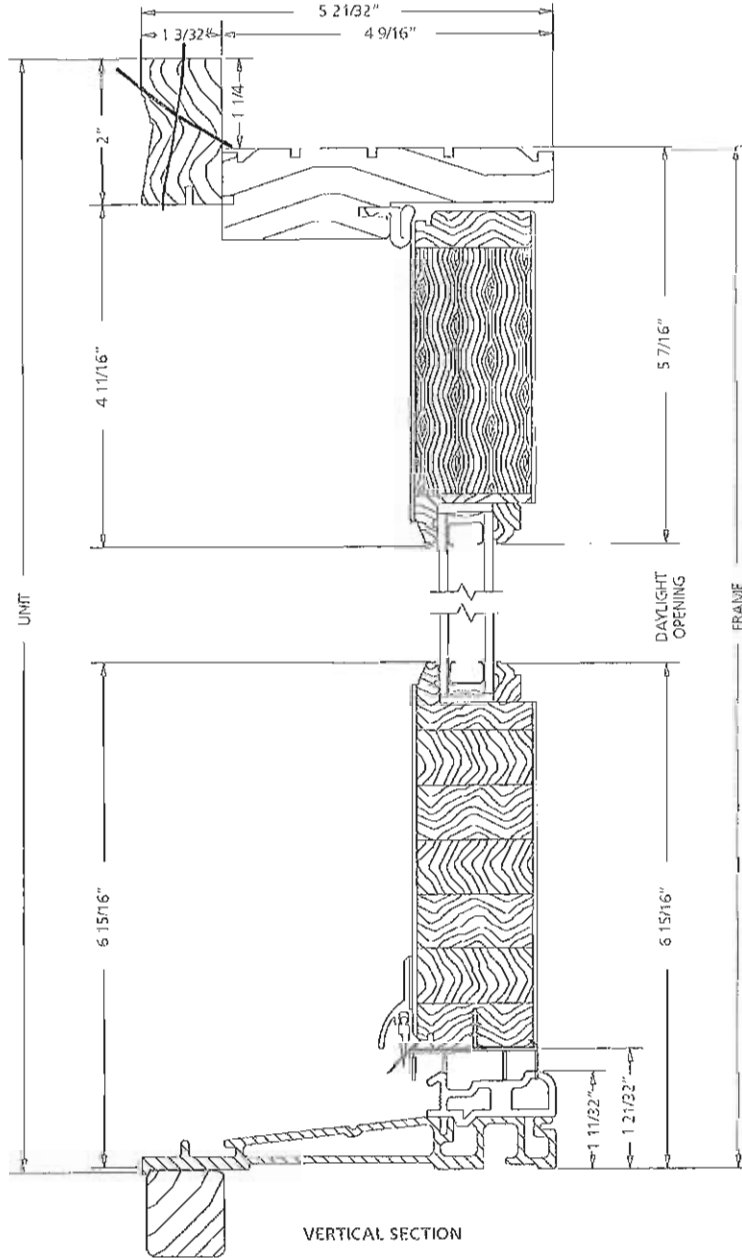

Note: Bottom rail shown is for 6'-0" doors. Bottom rail is 3" taller for doors over 6'-0".

SCALE: 6" = 1'

*See drawings
For trim.
TGT*

FRENCH IN-SWING

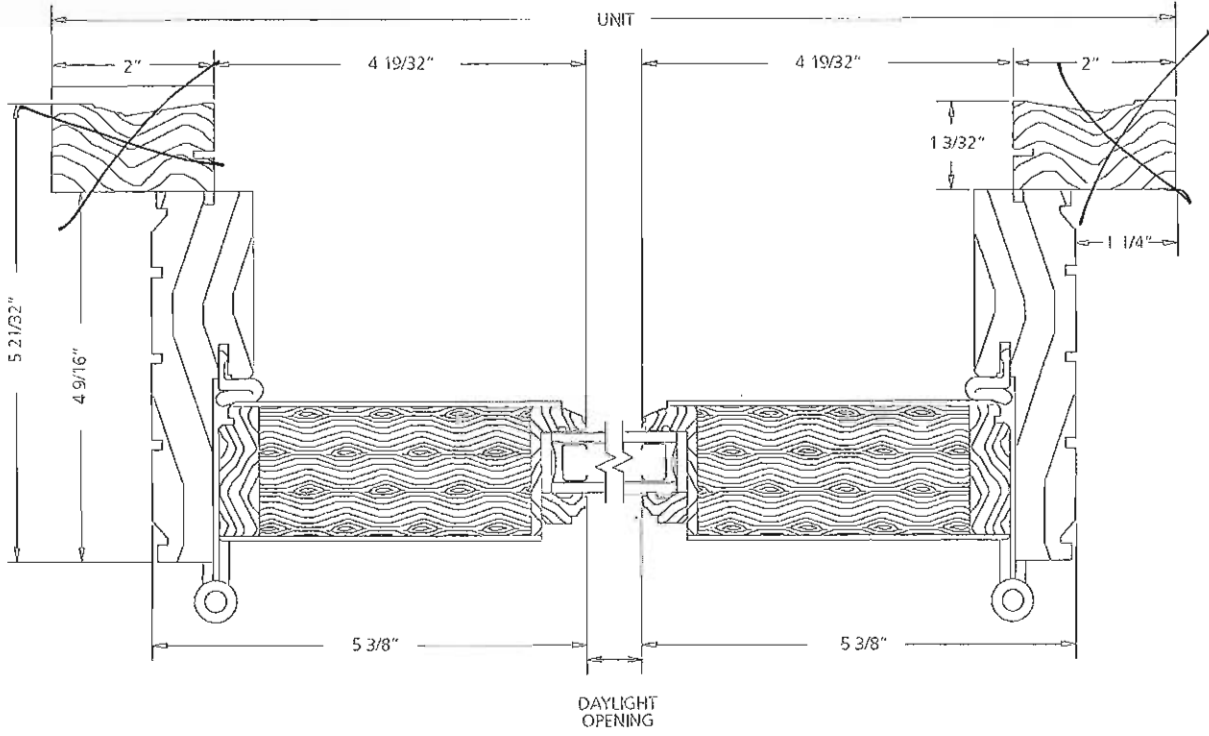

HORIZONTAL SECTION

Note: See page 14-65 for 4-0 French detail.

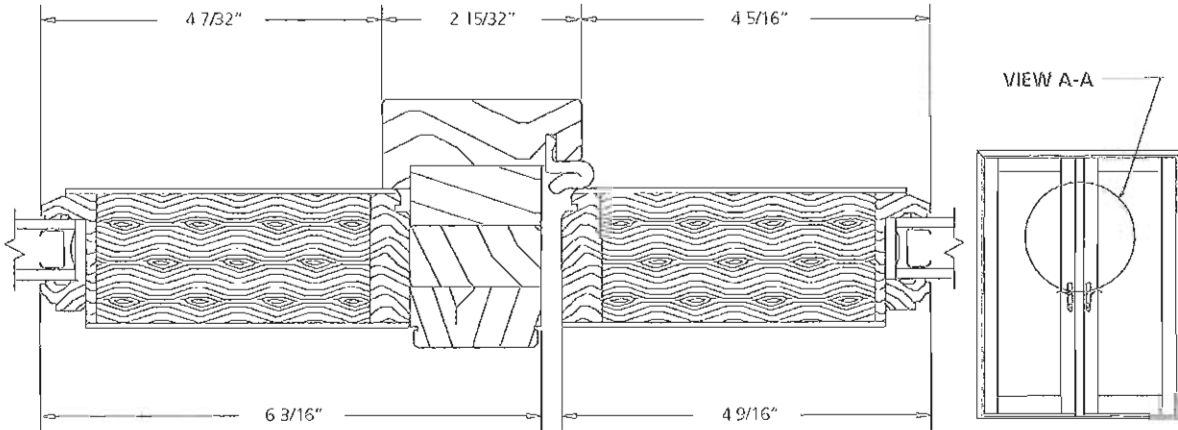

ASTRAGAL SECTION
VIEW A-A

SCALE: 6" = 1'

2-PANEL FRENCH UNITS

M.O. BRICKMOULD
M.O. ADAMS/FLAT CASING
ROUGH OPENING
FRAME SIZE
DAYLIGHT OPENING

50 3/8" [1260]
53 7/16" [1357]
47 3/8" [1203]
46 5/8" [1189]
12 5/8" [321] (2)

62 3/8" [1584]
65 7/16" [1662]
59 3/8" [1500]
58 5/8" [1486]
18 5/8" [473] (2)

66 3/8" [1686]
69 7/16" [1764]
63 3/8" [1602]
62 5/8" [1588]
20 5/8" [524] (2)

74 3/8" [1880]
77 7/16" [1967]
71 3/8" [1813]
70 5/8" [1799]
24 5/8" [626] (2)

80 15/16" [2056]
82 15/32" [2095]
79 9/16" [2001]
78 3/16" [1987]
65 11/16" [1668]

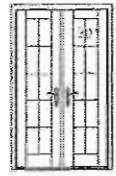

WOFRR406R

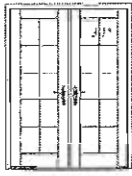

WOFRR506R

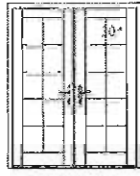

WOFRR546S

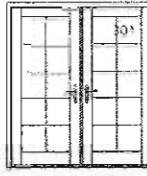

WOFRR606R

96 15/16" [2462]
98 15/32" [2501]
95 9/16" [2407]
94 3/16" [2393]
81 11/16" [2074]

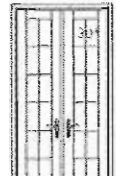

WOFRR408D

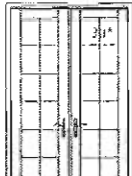

WOFRR508D

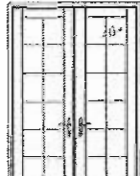

WOFRR548D

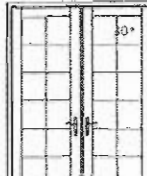

WOFRR608D

108 15/16" [2767]
110 15/32" [2806]
107 9/16" [2712]
106 3/16" [2698]
93 11/16" [2379]

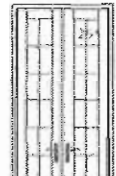

WOFRR400D

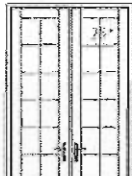

WOFRR500D

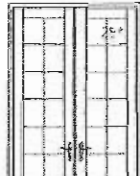

WOFRR540D

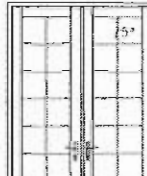

WOFRR600D

M.O. BRICKMOULD
M.O. ADAMS/FLAT CASING
ROUGH OPENING
FRAME SIZE
DAYLIGHT OPENING

54 3/8" [1381]
57 7/16" [1478]
51 3/8" [1324]
50 5/8" [1310]
14 5/8" [371] (2)

66 3/8" [1686]
69 7/16" [1764]
63 3/8" [1602]
62 5/8" [1588]
20 5/8" [524] (2)

70 3/8" [1788]
73 7/16" [1866]
67 3/8" [1704]
66 5/8" [1690]
22 5/8" [575] (2)

78 3/8" [1981]
81 7/16" [2068]
75 3/8" [1904]
74 5/8" [1890]
26 5/8" [676] (2)

90 3/8" [2276]
93 7/16" [2363]
87 3/8" [2209]
86 5/8" [2195]
72 5/8" [579] (2)

88 15/16" [2281]
90 15/32" [2320]
87 9/16" [2226]
86 3/16" [2212]
68 11/16" [1743]

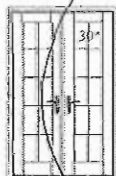

WOFRR406R



WOFRR506R

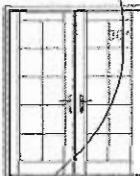

WOFRR546S

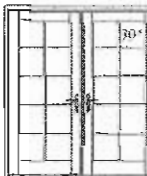

WOFRR606R

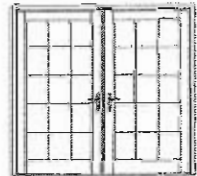

WOFRR606R

87 15/16" [2281]
89 15/32" [2320]
86 9/16" [2226]
85 3/16" [2212]
72 11/16" [1843]

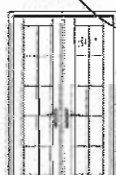

WOFRR407C



WOFRR507D

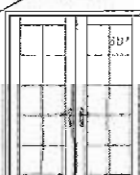

WOFRR547D

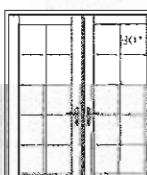

WOFRR607D

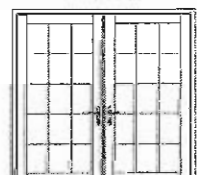

WOFRR607D

99 15/16" [2538]
101 15/32" [2577]
98 9/16" [2483]
97 3/16" [2469]
85 3/4" [2178]

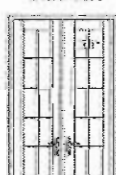

WOFRR409D



WOFRR509D

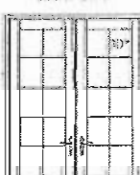

WOFRR549D

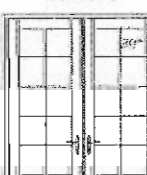

WOFRR609D

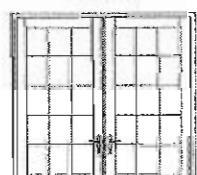

WOFRR609D

111 15/16" [2843]
113 15/32" [2882]
110 9/16" [2788]
109 3/16" [2774]
96 11/16" [2456]

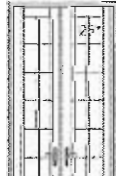

WOFRR406R

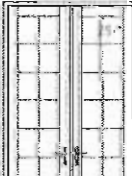

WOFRR506R

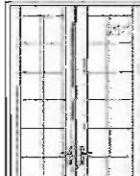

WOFRR546S

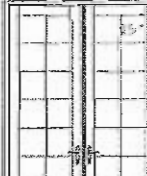

WOFRR606R

ELEVATION SYMBOL LEGEND:
M.O. = MASONRY OPENING
VALUES IN [] ARE IN MILLIMETER CONVERSIONS
VALUES IN {} ARE NUMBER OF DAYLIGHT OPENINGS PER UNIT
##* = NUMBER INDICATES OF SIGN PRESSURE WIND RATING
VALUES (BASED ON) CASING OPERATING HEIGHTS (11/12)
MULTI-POINT LOCKING HARDWARE FOR DR RATING

Note: Elevations shown DO NOT have exterior trim.
Subtract 1/2" (12.5) from M.O. (Masonry Opening)
for Unit Size. For other Trim Options refer to the Unit
Sizing, Rough Opening & Masonry Opening page.

SCALE: 1/8" = 1'

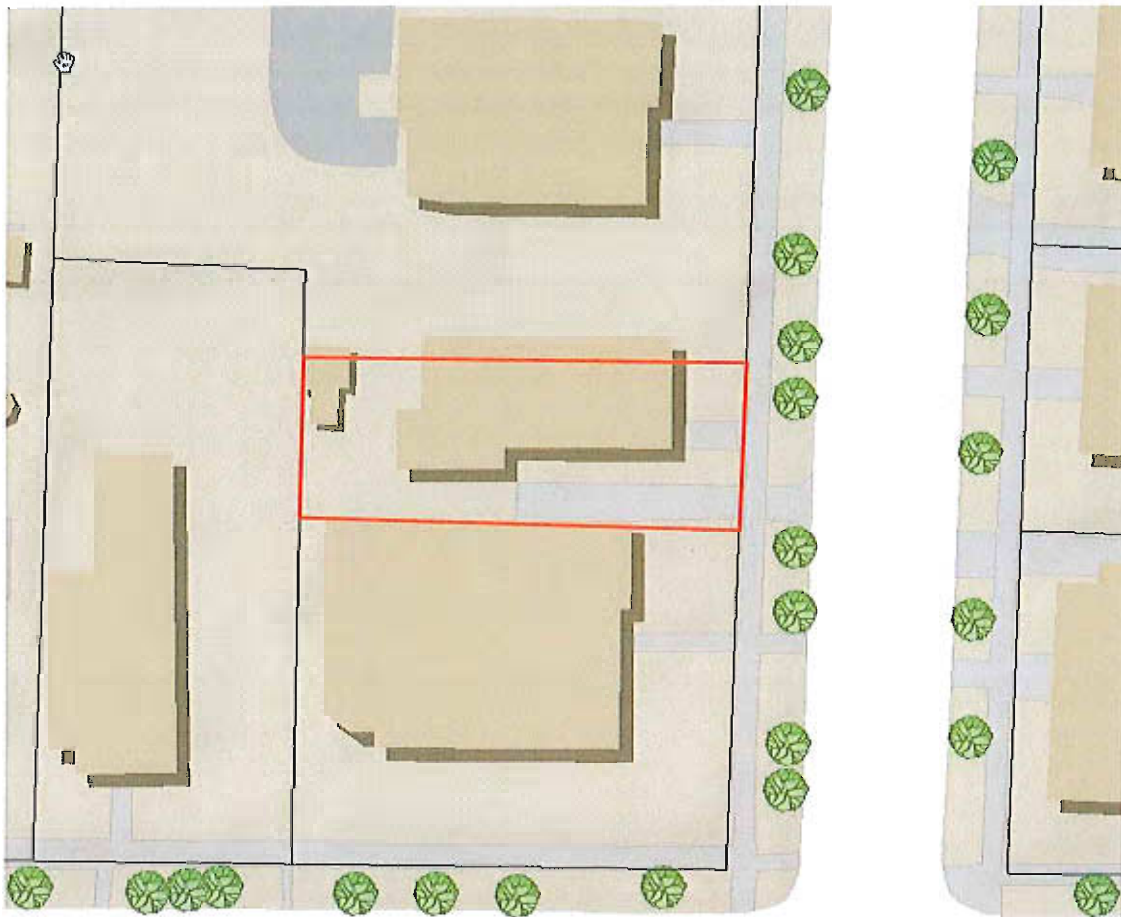

imaps-403Elm



aerial-403Elm



IMG_4974



IMG_4977



2013-12-13 11.11.14



2013-12-13 11.11.10



2013-12-13 11.10.44



2013-12-13 11.10.53



IMG_4982



2013-12-13 11.10.20



IMG_4962



IMG_4966

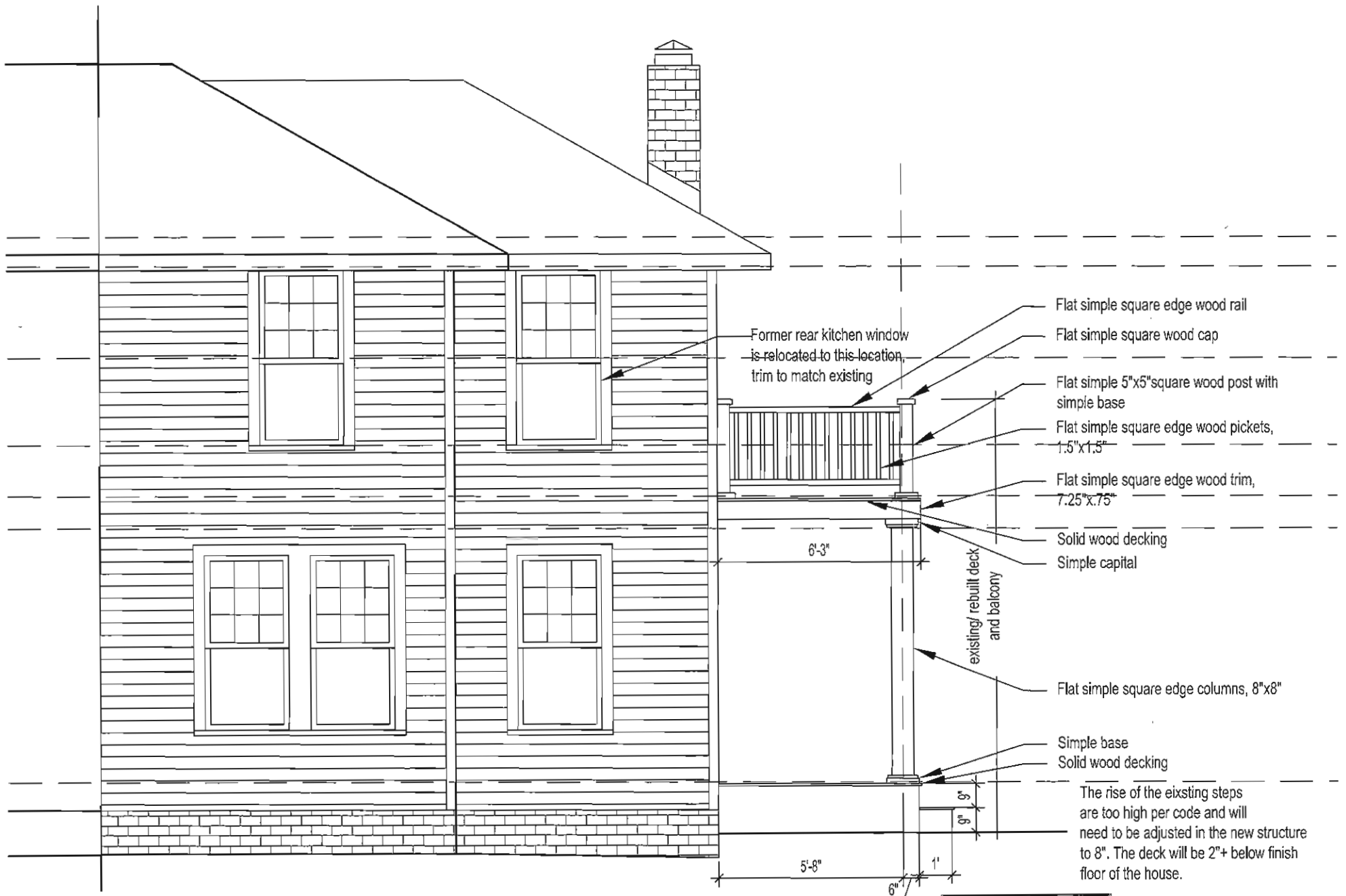

PELL ST studio

Architect
 Ashley Henkel Morris
 306 Pell Street
 Raleigh, NC 27604
 919.696.0970

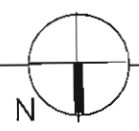

Proposed Portion of North Elevation
 Scale - 1/4" = 1'-0"



Proposed Portion of South Elevation

Scale - 1/4" = 1'-0"

PELL ST studio

Architect
 Ashley Henkel Morris
 306 Pell Street
 Raleigh, NC 27604
 919.696.0970



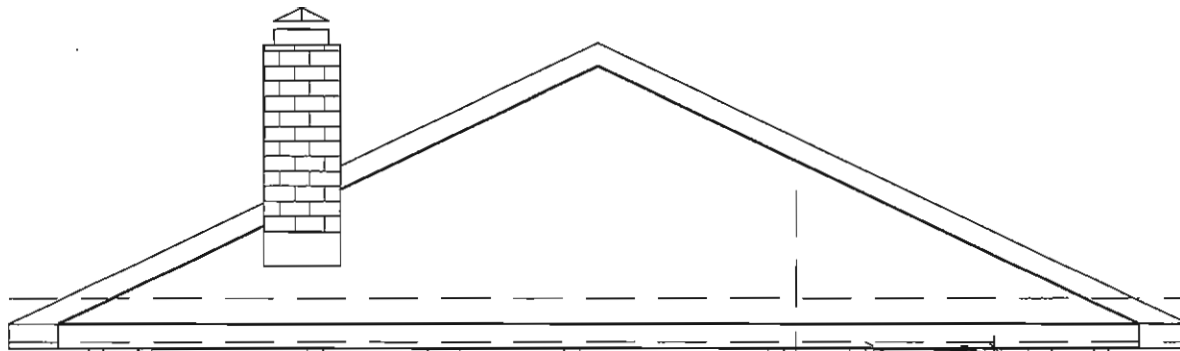

8'-0" clg under roof of porch

Wd beadboard clg with 1.5" bead

Single window to be replaced with two double hung windows, 8" mull, 9 over 1 grille pattern, trim to match existing

18" fixed window added here, no grille pattern. Trim to match existing.

Kitchen window will be replaced with swing patio doors out to expanded deck, no grilles, trim to match existing

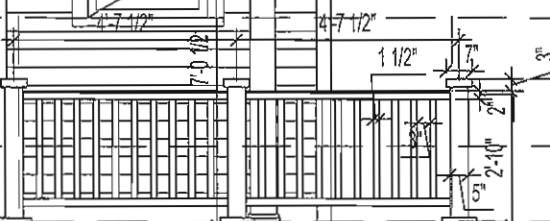

Wd beadboard clg with 1.5" bead

existing/ rebuilt deck and balcony

Flat simple wd trim for riser
Solid wood decking - larger width + length lumber

The rise of the existing steps are too high per code and will need to be adjusted in the new structure to 8". The deck will be 2"+ below finish floor of the house.

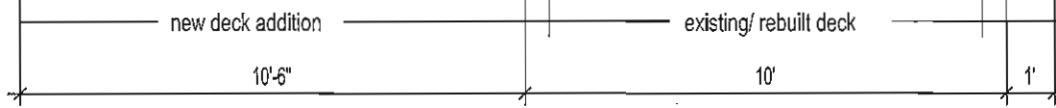

PELL ST studio

Architect
Ashley Henkel Morris
306 Pell Street
Raleigh, NC 27604
919.696.0970

Proposed West Elevation

Scale - 1/4" = 1'-0"



Tully, Tania

From: Tully, Tania
Sent: Thursday, February 06, 2014 12:06 PM
To: 'ashley henkel'
Subject: RE: 403 Elm - Two Level Deck Drawings

looks good!

Tania Georgiou Tully, Preservation Planner
Long Range Planning Division
Raleigh Department of City Planning
919.996.2674 **new phone number**
919.516.2684 (fax)
tania.tully@raleighnc.gov

From: ashley henkel [<mailto:ahenkelmorris@yahoo.com>]
Sent: Thursday, February 06, 2014 11:38 AM
To: Tully, Tania
Subject: 403 Elm - Two Level Deck Drawings

Tania

See what you think about these and let me know if you need for me to add anymore info. I am still waiting on the window rep to send me his quote that will have all the info that you requested for the mutins etc.

Thanks

Ashley Henkel Morris
919.696.0970
<http://pellstreetstudio.com>

Tully, Tania

From: Tully, Tania
Sent: Tuesday, February 04, 2014 12:53 PM
To: 'ashley henkel'
Cc: 'michiel.doorn@me.com'
Subject: RE: Minor Work App for 403 Elm St

Ashley –

I am reviewing the COA application for exterior changes at 403 Elm Street and need the following additional information in order to complete my review:

- muntin (grid) details for the new windows on the 2nd floor rear elevation
- confirmation that the trim details on the relocated and new windows and new doors will match the existing trim as shown in photos
- larger scale drawings of the rebuilt balcony

Thanks!
Tania

Tania Georgiou Tully, Preservation Planner
Long Range Planning Division
Raleigh Department of City Planning
919.996.2674 **new phone number**
919.516.2684 (fax)
tania.tully@raleighnc.gov

From: ashley henkel [<mailto:ahenkelmorris@yahoo.com>]
Sent: Thursday, January 30, 2014 1:22 PM
To: Tully, Tania
Subject: Re: Minor Work App for 403 Elm St

Here is the imaps data. Looks like all the trees are on other people's property except for the ones in the front of the house. Here are a couple more photos showing that the back yard is pretty clear of trees. Let me know if you need anything else.

Thanks!

Ashley Henkel Morris
919.696.0970
<http://pellstreetstudio.com>

On Thursday, January 30, 2014 1:05 PM, ashley henkel <ahenkelmorris@yahoo.com> wrote:
Sure thing I will get that over to you.

Thanks

Ashley Henkel Morris
919.696.0970
<http://pellstreetstudio.com>

Tully, Tania

From: Tully, Tania
Sent: Wednesday, February 05, 2014 9:25 AM
To: 'Ashley Morris'
Cc: 'ashley henkel'
Subject: RE: 403 Elm St - Revised elevations with more notes

Ashley –

For the window muntins I need the specs from the manufacture. I can see from the drawings that the pattern is 9/1, but I am looking for the width and depth of the muntins and evidence that they are simulated divided lights, not simply grilles-between-the-glass or snap-in-muntins.

For the balcony, dims and notes detailing what is existing is perfect is that is what is being rebuilt.

Thanks,
Tania

Tania Georgiou Tully, Preservation Planner
Long Range Planning Division
Raleigh Department of City Planning
919.996.2674 **new phone number**
919.516.2684 (fax)
tania.tully@raleighnc.gov

From: Ashley Morris [<mailto:pellststudio@gmail.com>]
Sent: Tuesday, February 04, 2014 1:47 PM
To: Tully, Tania
Subject: 403 Elm St - Revised elevations with more notes

Hey Tania'

Something wacky is going on with yahoo right now so I am having to send things to you from my other email address.

Here are the elevations that we submitted with new notes that state the upstairs grilles are 9 over 1 to match the existing windows along with the trim to match existing. The door trim will also match existing - new note helps show this.

I made these pdfs 1/4"scale and they will print out on 11x17.

Can you clarify what else you need for the balcony? Do we need dims and notes detailing what is existing?

Thanks!

--
Ashley Henkel Morris
owner/registered architect
919.696.0970
<http://pellstreetstudio.com>